

Building Your Dream

Building Materials Catalogue



SHERAV
Hong Kong Ltd



INDEX

MDF

P.3-P.8

- Plain MDF
- Melamine MDF
- UV Coated Glossy MDF
- Textured Finish MDF
- Slot Board

Plywood

P.9-P.14

- Film Faced Plywood
- WBP Plywood
- Commercial Plywood
- Fancy Plywood
- Melamine Plywood

Boards

P.15-P.18

- Block Board
- Hard Board
- Particle Board

Flooring

P.19-P.20

- PVC Vinyl Flooring

Ceiling

P.21-P.48

- Gypsum Ceiling Tiles
- Mineral Fiber Ceiling Tiles
- Aluminium Ceiling Tiles
- Gypsum Boards
- Gypsum Ceiling & Partition Accessories
- Gypsum Ceiling Tiles Accessories
- Aluminium Ceiling Accessories

Hardware

P.49-P.52

- Screws & Nails
- Adhesives
- Glass Blocks
- Tools

Glass

P.53-P.62

- Clear Float Glass
- Low Iron Glass
- Tinted Glass
- Reflective Glass
- Low Emissivity Glass
- Laminated Glass
- Silver Mirror
- Aluminum Mirror

Doors

P.63-P.116

- Steel Door
- Steel & Aluminum Door
- Steel Glass Door
- Stainless Steel Door
- Luxury Copper Door
- Steel Wood Door
- Luxury PVC Wooden Door
- PVC Wooden Door
- American Steel Door
- HPL Door
- Melamine Door
- Bathroom Door
- Turkey Door

Roofing

P.117-P.120

- Classical Tile
- Modern Classical Tile
- Shingle Tile
- Rainbow Tile
- Makuti Grained Tile

Piping

P.121-P.142

- PVC Rainwater Gutter & Fitting
- PPR
- PPH
- CPVC

Electronics

P.143-P.152

- Voltage Stabilizer
- Switches

MDF

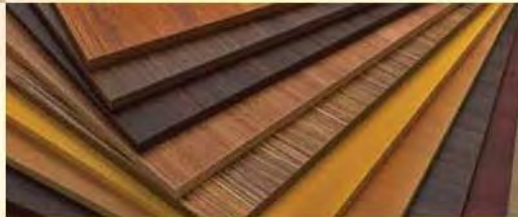

- Plain MDF
- Melamine MDF
- UV Coated Glossy MDF
- Textured Finish MDF
- Slot Board





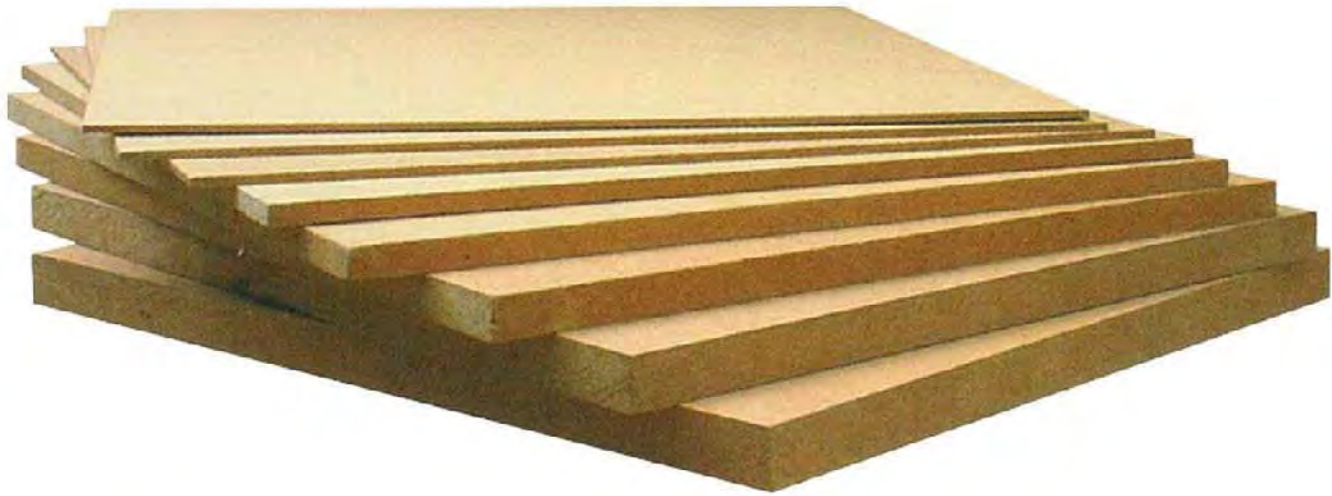









Plain MDF



MDF

THICKNESS (actual size)

3 mm		22 mm	
4 mm			
6 mm			
9 mm		25 mm	
12 mm			
15 mm		30 mm	
16 mm			
18 mm		40 mm	

Standard Size: 4' x 8'
Also available in 6' x 12', Thickness 12mm & 18mm

MDF

Plain MDF

Medium-Density Fibreboard (MDF) is an engineered wood product made by breaking down hardwood or softwood residuals into wood fibres and forming panels by applying high temperature and pressure. MDF is generally denser than plywood. It is made up of separated fibres, but can be used as a building material similar in application to plywood.



Sizes:

4' x 8' (standard)

6' x 12' (also available)

Melamine MDF

Melamine is a hard plastic synthetic finish which is applied to particle board surfaces.

Melamine Chipboard or Particle board is an engineered wood product manufactured from wood chips, sawmill shavings, or even sawdust, and a synthetic resin or other suitable binder, which is pressed and extruded.



Zebrano
No.SH71



Spanish Olive Dark
No.SH73



Spanish Olive Light
No.SH74



Classic Walnut
No.SH69



Wild Pear
No.SH14



Pirch Burl
No.SH11



Metallic Silver
No.SH07



Sliver Brushed
No.SH06

MDF

UV Coated Glossy MDF

Sizes:
1200mm x 2440mm

Thickness: 3 to 18mm

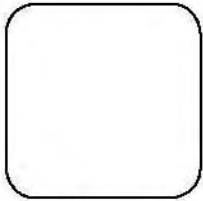

White
UV-SH01



Teak
UV-SH02



Sapele
UV-SH03

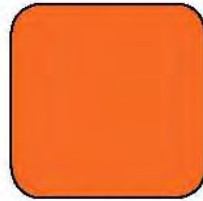

Orange
UV-SH04



Oak
UV-SH05



Maple
UV-SH06

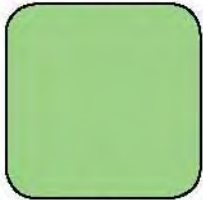

Light Green
UV-SH07



Green
UV-SH08



Grey
UV-SH09



Cherry
UV-SH10

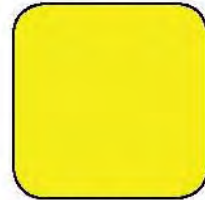

Bright Yellow
UV-SH11



Blue
UV-SH12



Black
UV-SH13



Black Walnut
UV-SH14



Beech
UV-SH15



Mahogany
UV-SH16



Bright Red
UV-SH17



Textured Finish MDF

MDF



Burma Teak
No.SH35



Crown Teak
No.SH57



Burl
No.SH43



Moon Cherry
No.SH65



Crown Cherry
No.SH64



Walnut
No.SH47



Rich Mahogany
No.SH66



Rose Wood
No.SH45



Mahogany Dark
No.SH44



Wenge
No.SH09

Slot Board

Slot Boards have been utilized in the retail industry for wall coverings and product displays for years. Typically manufactured from MDF with slots to accept multiple accessories, they are often painted, digitally printed on or laminated from an array of substrates to give the retail space the desired look.



SB-SH02



SB-SH01



SB-SH03



Plywood



- Film Faced Plywood
- WBP Plywood
- Commercial Plywood
- Fancy Plywood
- Melamine Plywood

Plywood

Film Faced Plywood

Film Faced Plywood is a kind of Plywood overlaid by Phenolic Resin Film, Which has excellent function of Waterproof, FFP is mainly and Widely used in Construction Site as Shuttering Formwork.

Products: Film Faced Plywood
Standard Size: 1220mm x 2440mm
Thickness: 6 to 30mm
Species Core: Polar, Combi & Hardwood
Face/Back: Brown & Black Film
Grade: Requested
Glue: MR, Melamine & WBP Glue
Grammage: 80/m², 120g/m²



Chinese
Black Film
FFP-SH01



Finland
Brown Film
FFP-SH02



Brown Film
FFP-SH03



Dynea Film
FFP-SH04



Anti-Slip Film
FFP-SH05

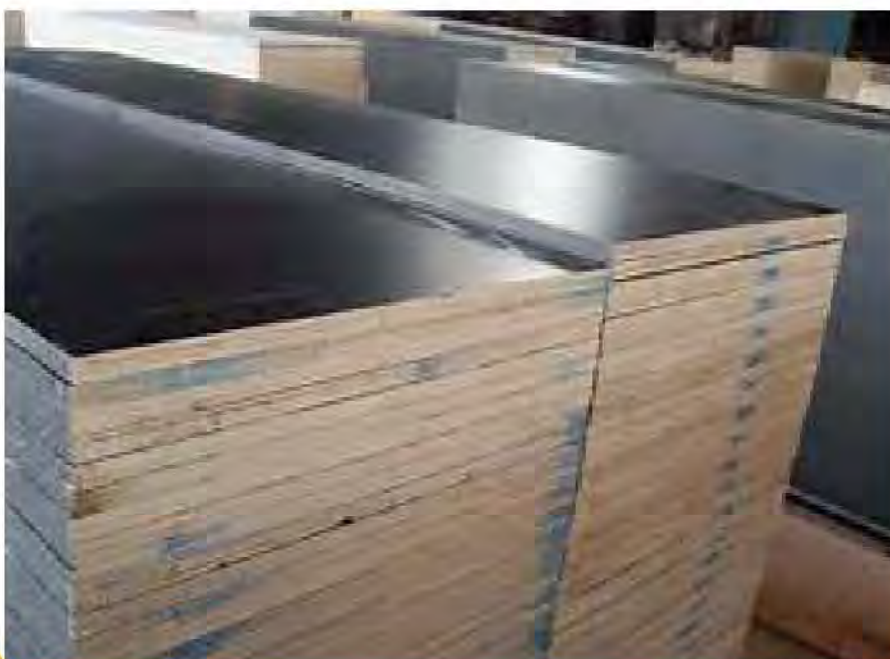

WBP Plywood

WBP is a glue standard that was developed in Great Britain and is set down in British Standards Institution standard 1203:1963, "Specification for synthetic resin adhesives (phenolic and aminoplastic) for plywood." This standard identifies four categories of plywood glue on the basis of durability. WBP is the most durable classification. In descending order of durability, the other glue classes are Boil-Resistant, or BR; moisture-resistant, or MR; and interior, or INT. According to the Food and Agricultural Organization of the United Nations, properly formulated WBP plywood is the only plywood recommended for exterior use without reservation.



Plywood

Commercial Plywood

Commercial Plywood is firmly pressed and joined with each other to make a plywood sheet. Commercial plywood is also known as MR Grade plywood. The acronym MR stands for Moisture Resistant, but moisture resistant is not the same as water resistant.

Products: Commercial Plywood

Standard Size: 1220mm x 2440mm or 1250mm x 2500mm

Thickness: 2.2 to 30mm

Species Core: Polar, Combi & Hardwood

Face/Back veneer: Okoume, Bintangor, Pencil Cedar etc.

Grade: BB/CC or requested

Glue: MR, Melamine & WBP Glue

Utilization: Laminating; Furniture; Building



Bintangor
CP-SH01



Pine
CP-SH02



Keruing
CP-SH03



Okoume
CP-SH04

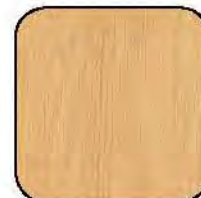

Pencil
CP-SH05



Marine
CP-SH06

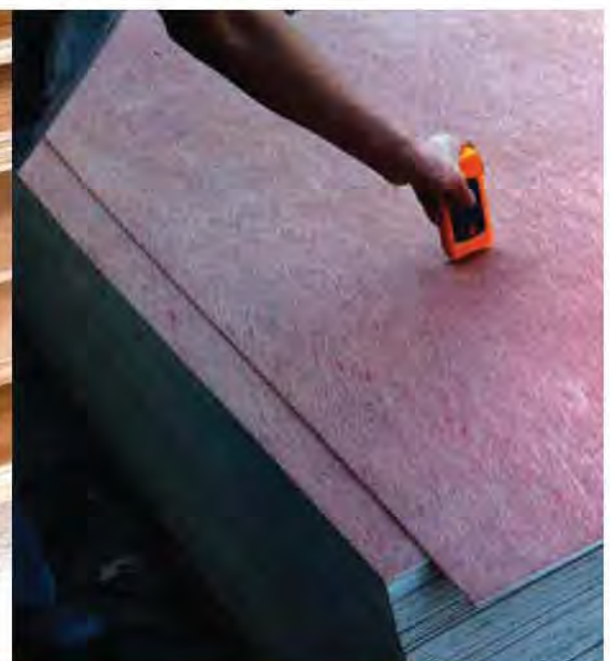

Fancy Plywood

Fancy Plywood is an excellent material for wall units, desks, custom cabinetry, wood designs, and kitchens. We offer this plywood in a range of grades and woods, including birch (of which we maintain an inventory at major U.S. ports), Red Oak, Maple, and Cherry.

Products: Fancy Plywood
Standard Size: 1220mm x 2440mm
Thickness: 1.60 to 3.60mm
Utilization: Furniture; Building
Color: Natural Veneer, EP, EV



Red Padauk
FP-SH01



Red Oak
FP-SH02



Dark Padauk
FP-SH03

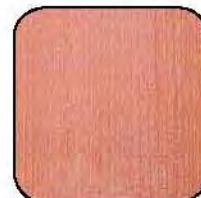

Red Birch
FP-SH04

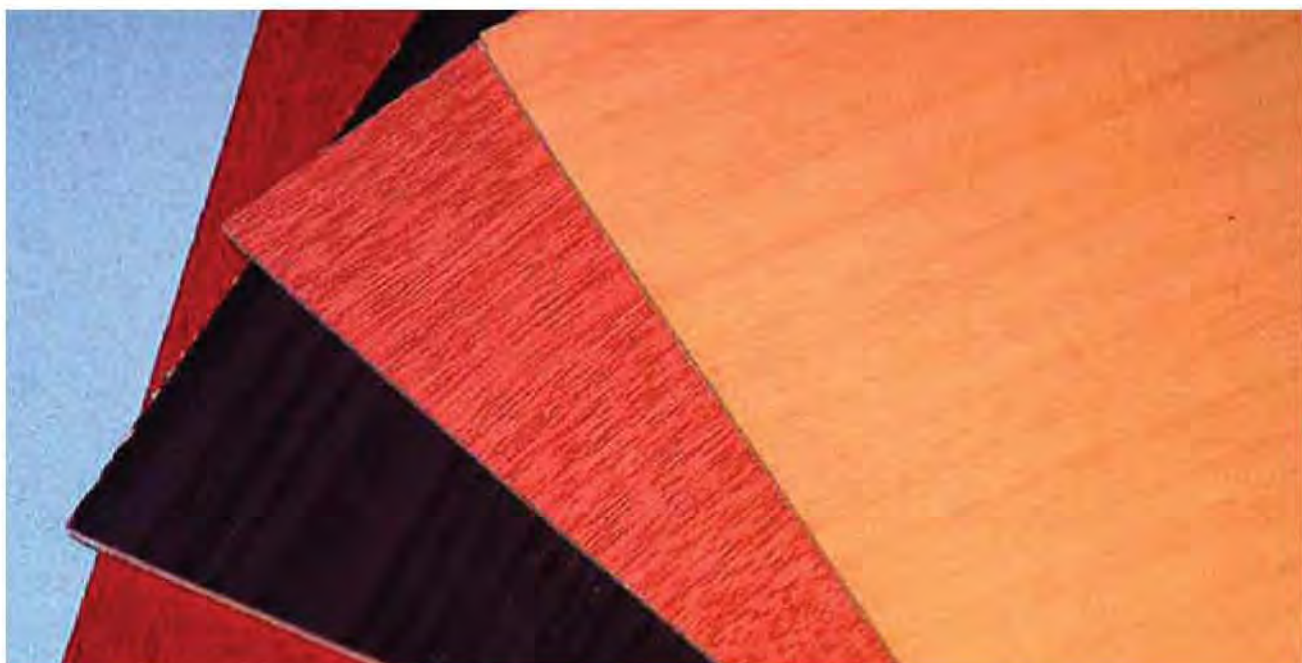

Boards

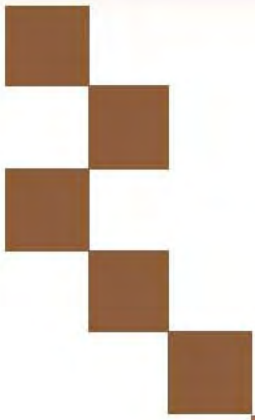

- Block Board
- Hard Board
- Particle Board



Block Board

Block Board is a wood based panel, made up of a core of softwood strips glued together. The strips may be up to about 28mm wide and are placed edge to edge and sandwiched between veneers of softwood, hardwood or thin MDF or particleboard, glued under high pressure. The internal strips are generally made of light weight poplar wood or spruce.

Products: Block Board

Standard Size: 1220mm x 2440mm

Thickness: 15mm, 18mm, 21mm, 35mm, 42mm

Species Core: Combi & Poplar & Hardwood & Falcata

Face/Back Veneer: Okoume, Bintangor, Pencil Cedar, meranti or any natural veneer

Utilization: Laminating; Furniture; Building

Sr.No	Property	Unit	Test Method	Value of Test	Result	
1	Moisture Content	%	EN 322	8	Check out	
2	Density	Kg/m ³	EN 323	516	Check out	
3	Bonding Quality	Bonding Quality	Mpa	EN 314	Max:1.41 Min:0.77	Check out
		Damage Rate	%	55%	
4	Bending Modulus of Elasticity	Longitudinal	Mpa	EN 310	5983	Check out
		Lateral			4719	
5	Bending StrengthN/mm	Longitudinal	Mpa		48.68	Check out
		Lateral			39.87	
6	Envir for Test	20°C				
7	Test conclusion	The quality of products comply with various standards like GB/T9846-2004 and EN314-1:2004				



Boards

Hard Board

Hardboard is a type of fibreboard, which is an engineered wood product. It is similar to particle board and medium-density fibreboard, but is denser and much stronger and harder because it is made out of exploded wood fibres that have been highly compressed. Unlike particle board, it will not split or crack.

Products: Hard Board
Standard Size: 1220mm x 2440mm
Thickness: 2.00 to 4.00mm
Utilization: Furniture; Building



Plain 1
HB-SH01



Plain 2
HB-SH02



Plain 3
HB-SH03



Plain 4
HB-SH04



Perforated 1
HB-SH05



Perforated 2
HB-SH06



Particle Board

Particle board is a manufactured board that is often used in furniture because it can be made cheaply and is more affordable than solid timber but has a similar look.

It is a good alternate option when buying furniture to a budget because it gives the impression of solid timber and it usually lasts for long periods of time if looked after and taken care of well, like all solid timber.

Products: Particle Board

Standard Size: 1220mm x 2440mm or 1525mm x 2440mm
or 1830mm x 2440mm

Thickness: 3.0mm to 36mm

Species Core: Poplar & pine

Glue: E1 or E2

Density: 640 to 680kg

Melamine Particle Boards: Any Color, One Side or Two Side

Sr.No	Property	Unit	Standard	Value of Test	Result
1	Combine theintensity inside	Mpa	≥ 0.50	0.56	Check out
2	Stntic bending strength	Mpa	≥ 22	28	Check out
3	Elastic modulus	Mpa	≥ 2500	2820	Check out
4	Screw strength	N	Face ≥ 1000	1230	Check out
			Edge ≥ 800	900	
5	Thickness swelling rate	%	≤ 12	10	Check out
6	Density	KG/M ³	≥ 700	730	Check out
7	Moisure	%	6-12	8	Check out
8	Formaldehyde Content/Emission	Mg/100g	$\leq 30\text{mg}/100\text{g}(\text{E}2)$	18	Check out
9	Test conclusion	The quality of products comply with various standards like GB/T9846-2004 and EN314-1:2004			



Flooring

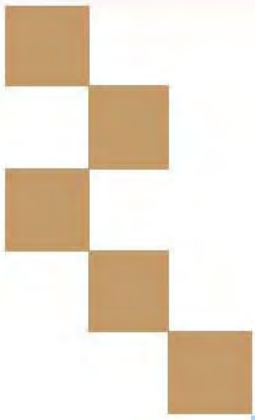

■ PVC Vinyl Flooring



PVC Vinyl Flooring

PVC Vinyl Flooring tiles are made of a composite of PVC and fibre, producing a thin and fairly hard tile. The main advantages of PVC tiles are low cost, ease of replacing individual tiles.

Size: 457mm x 457mm

Popular Shades



Metallic Red
VF-SH01



Metallic Black
VF-SH02



Metallic Yellow
VF-SH03



Metallic Blue
VF-SH04



Sand Stone 1
VF-SH05



Sand Stone 2
VF-SH06



Plain Beige
VF-SH07



Plain Gray
VF-SH08



Antislip
Dark Gray
VF-SH09



Antislip Silver
VF-SH10



Flooring

PVC Vinyl Flooring

Film Faced Plywood is a kind of Plywood overlaid by Phenolic Resin Film, Which has excellent function of Waterproof, FFP is mainly and Widely used in Construction Site as Shuttering Formwork.

Size: 914mm x 157mm x 1.5mm

Wood Grain Design



Cherry Classic
VF-SH11



Oak
VF-SH12



Merbau
VF-SH13



Wenge
VF-SH14



Ebony
VF-SH15



Maple
VF-SH16



Teak
VF-SH17



Walnut
VF-SH18



Beech
VF-SH19



Ceiling

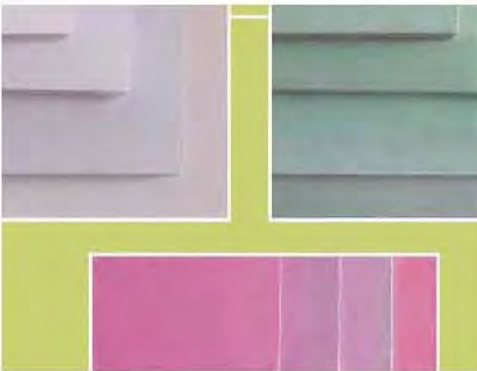
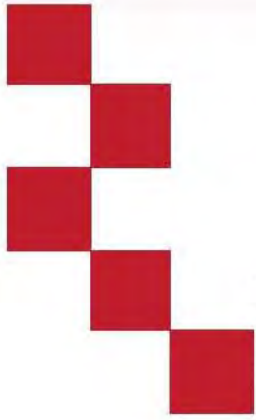

- Gypsum Ceiling Tiles
- Mineral Fiber Ceiling Tiles
- Aluminium Ceiling Tiles
- Gypsum Boards
- Gypsum Ceiling & Partition Accessories
- Gypsum Ceiling Tiles Accessories
- Aluminium Ceiling Accessories

Ceiling



Ceiling

Gypsum Ceiling Tiles

Ceiling Tiles are manufactured with an incombustible gypsum core, lined with paper bonded on both surfaces.

Specification

Size: Metric System - 595mm x 595mm / 600mm x 600mm
British System - 603mm x 603mm / 603mm x 1210mm

Thickness available: 7mm, 7.5mm, 8mm, 9mm, 10mm, 11mm, 12mm

Technical Specification

SURFACE DISPOSAL	PVC FILM IMPORTED FROM TAIWAN AND ALUMINUM FOIL FOR BACK SIDE
PERMISSIBLE TOLERANCE	LENGTH $\leq \pm 2.0\text{mm}$
	WIDTH $\leq \pm 2.0\text{mm}$
	THICKNESS $\leq \pm 0.5\text{mm}$
	DIAGONAL $\leq \pm 1.5\text{mm}$
NOISE REDUCTION COEFFICIENT	0.1-0.3
UNIT AREA QUALITY	7mm < 6.5kg/m ² 8mm < 7.5kg/m ² 9mm < 8.5kg/m ²
LOAD AT BREAK	7mm $\geq 110\text{N}$ 8mm $\geq 120\text{N}$ 9mm $\geq 140\text{N}$
FIREPROOF PERFORMANCE	ACCORDING WITH CHINESE STANDARD GB624-1997
CERTIFICATE & STANDARD	CE En13964

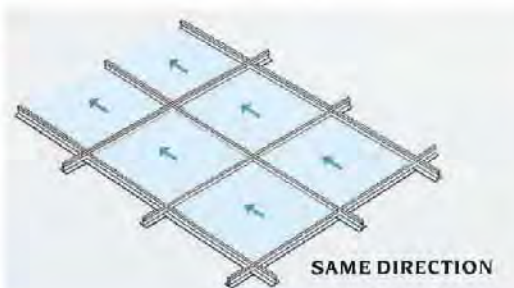
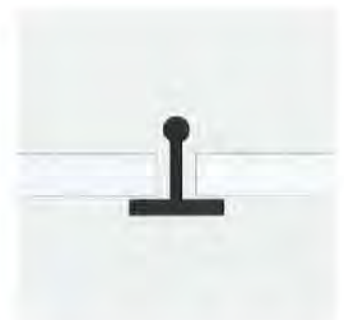
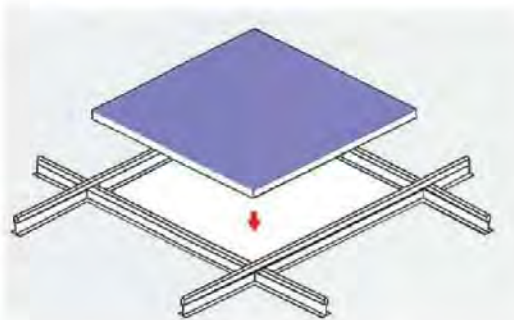

Gypsum Ceiling Tiles



GCT-SH01

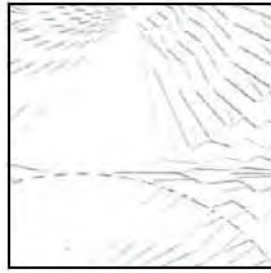

GCT-SH02

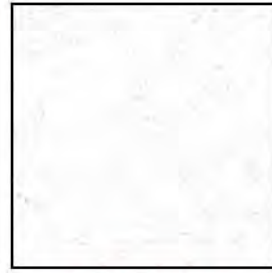

GCT-SH03



GCT-SH04



GCT-SH05



GCT-SH06



GCT-SH07



GCT-SH08

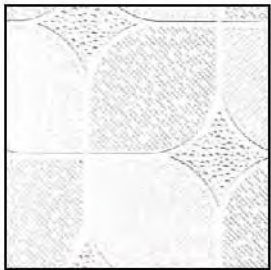

GCT-SH09

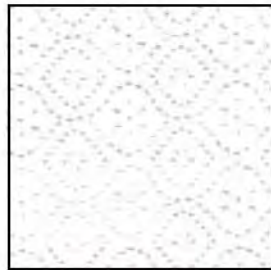

GCT-SH10

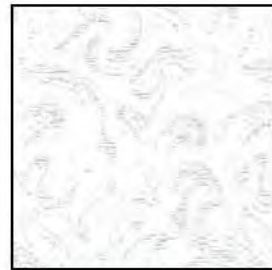

GCT-SH11

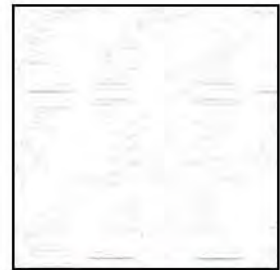

GCT-SH12

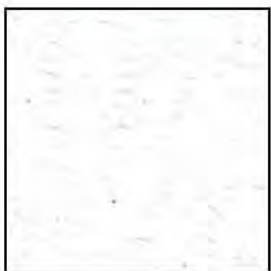

GCT-SH13



GCT-SH14



GCT-SH15



GCT-SH16



GCT-SH17



GCT-SH18



GCT-SH19



GCT-SH20

Ceiling

Gypsum Ceiling Tiles



GCT-SH21



GCT-SH22

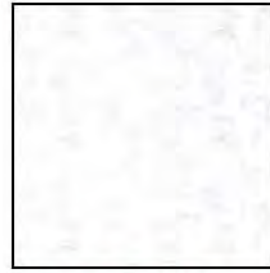

GCT-SH23



GCT-SH24



GCT-SH25



GCT-SH26

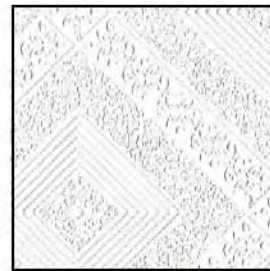

GCT-SH27



GCT-SH28



GCT-SH29



GCT-SH30



GCT-SH31



GCT-SH32



GCT-SH33



GCT-SH34



GCT-SH35



GCT-SH36



GCT-SH37



GCT-SH38



GCT-SH39

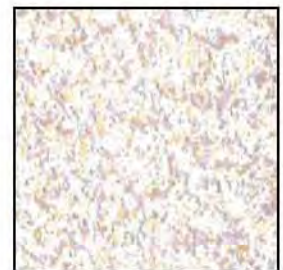

GCT-SH40

Gypsum Ceiling Tiles



GCT-SH41



GCT-SH42



GCT-SH43



GCT-SH44



GCT-SH45



GCT-SH46



GCT-SH47



GCT-SH48

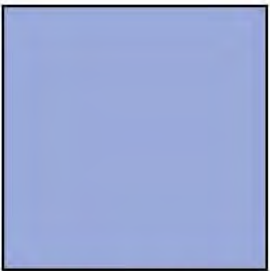

GCT-SH49

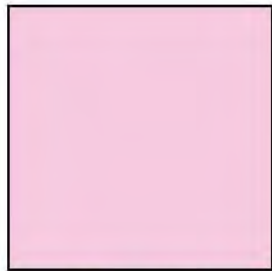

GCT-SH50



GCT-SH51

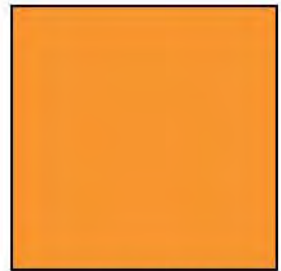

GCT-SH52

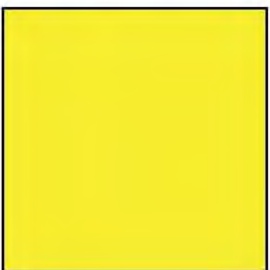

GCT-SH53



GCT-SH54

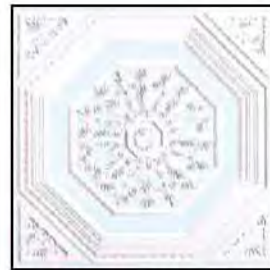

GCT-SH55



GCT-SH56



GCT-SH57



GCT-SH58



GCT-SH59



GCT-SH60

Ceiling

Gypsum Ceiling Tiles



GCT-SH62



GCT-SH63



GCT-SH64



Mineral Fiber Ceiling Tiles

Accessible acoustical ceiling system with fine non-directional fissured panel

Specification

Ltems	Units	Enterprise standard	Measured data	Test method	Testing unit
Density	Kg/m3	≤500	268average	Q/JCSBM 001-2004	China National Center For Quality Supervision Andtest Of Construction Engineering
Bending failure bearing	N	≥150 thick 13mm ≥120 thick 14mm ≥140 thick 14mm ≥180 thick 18mm ≥200 thick 19mm	125 182 209 269 321 372 403		
Water cintent	%	≤3	2		
Dam ping deflection	Mm	≥3.5	2.8-0.8 12-18mm thick12-18mm		
Radionuclide Limit	index of radiation	TypeA Ra≤1.0 R≤1.3	0.2 0.3	GB6566-2001	
Thermal conductivity coefficient	W/mk	≤0.065	0.0475	GB/T1094-1988	
Noise reduction coefficient		≥0.45 GH type ≥0.3 others	0.45-0.68	GBJ47-1983	
Combustion property	Class	Class B1	Class B1	GB/T8625-1988	

Ten Year Warranty For Star. Shine Mineral Fiber Decorative Acoustic Board



- The products should not be installed and used in vibration environment or chemical gas environment.
- The using temperature should be controlled in 80%.
- The mineral fiber decorative acoustic board of engineering series shall not be used to support any other materials.
- The mineral fiber decorative acoustic board of engineering and baking keel shall be stored in clean and dry place before installation. If the above-mentioned conditions are met but the boards still sink(the center of the boards sink for more than 2.5mm or fail to meet the standard of 《JC670-1997》, within 10 days staring form the discovery of sinking.

Ceiling

Mineral Fiber Ceiling Tiles





Specification







Size: Metric System - 595mm x 595mm / 600mm x 600mm
 300mm x 1200mm / 600mm x 1200mm
 British System - 603mm x 603mm / 603mm x 1210mm

Thickness available: 8mm, 10mm, 12mm, 14mm, 15mm, 18mm

Technical Specification

TECHNICAL SPECIFICATION	
MATERIAL	Wet-formed mineral fiber
SURFACE FINISH	Factory-applied vinyl latex paint
COLOUR	White
NRC	0.5
CAC	Minimun 30
EDGE DETAIL	Angled Tegular
	Square Lay-on
LIGHT REFLECTANCE	Minimun LR0.8'
RH PERFORMANCE	Appropriate for relative humidity up to 75% to 95%, Temperature up to 86° F(30°C)
INSULATION VALUE	Average R Factor(at75° F,24°C) is 1.31(BTU units), 0.23(Watts units)
CERTIFICATE & STARNARD	CE En13162

PRODUCT CHARACTERISTIC	
 <p>fire proof performance Standard:GB8624-1997 Level:B1</p>	 <p>Rh75 to Rh95 performance</p>
 <p>Light reflectance:Minimun LR0.80</p>	 <p>Insulation:Average R Factor (at 75 degree)is 1.31(BTU units), 0.23(Watts units)</p>

EDGE		
 <p>ADHESIVE AND NAILS</p>	 <p>SQUARE</p>	 <p>TEGULAR</p>
 <p>CONCEALED</p>	 <p>SHIPLAP</p>	 <p>LINEAR SHIPLAP</p>

Installation of Ceiling

Installation of Mineral Fiber Ceiling

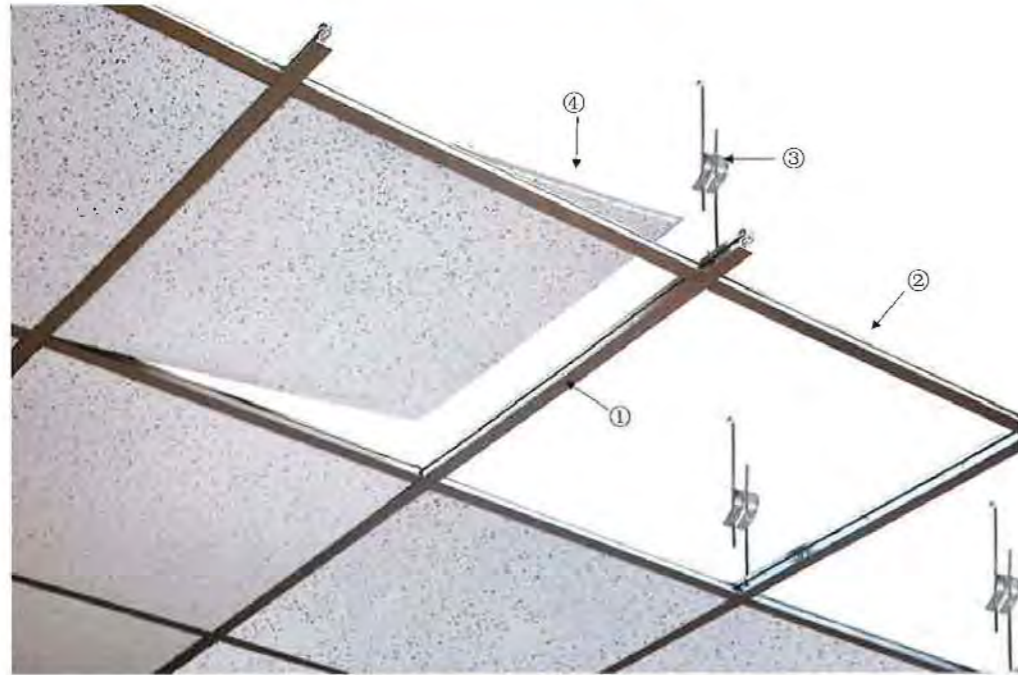

- ① Main tee
- ② Cross tee
- ③ Hanger for T-grid
- ④ Mineral fiber tile

Specification



METRIC SYSTEM

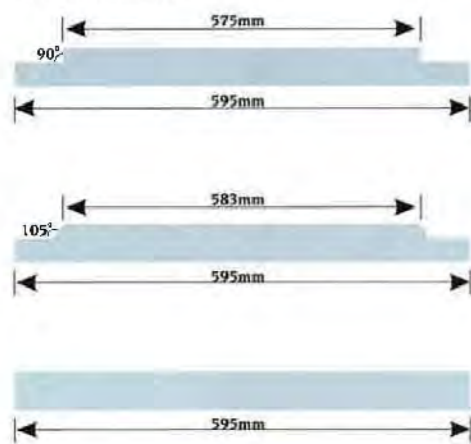

BRITISH SYSTEM

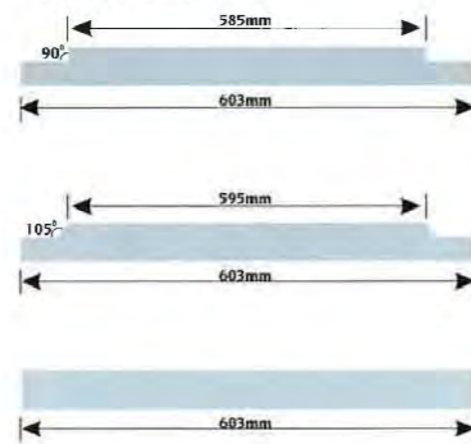

Installation of Ceiling

Specification

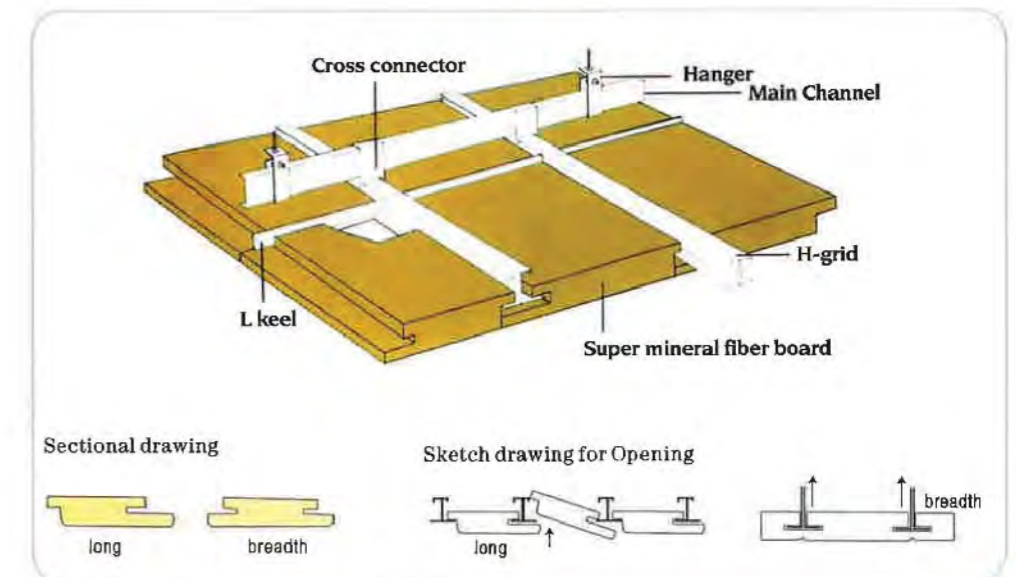
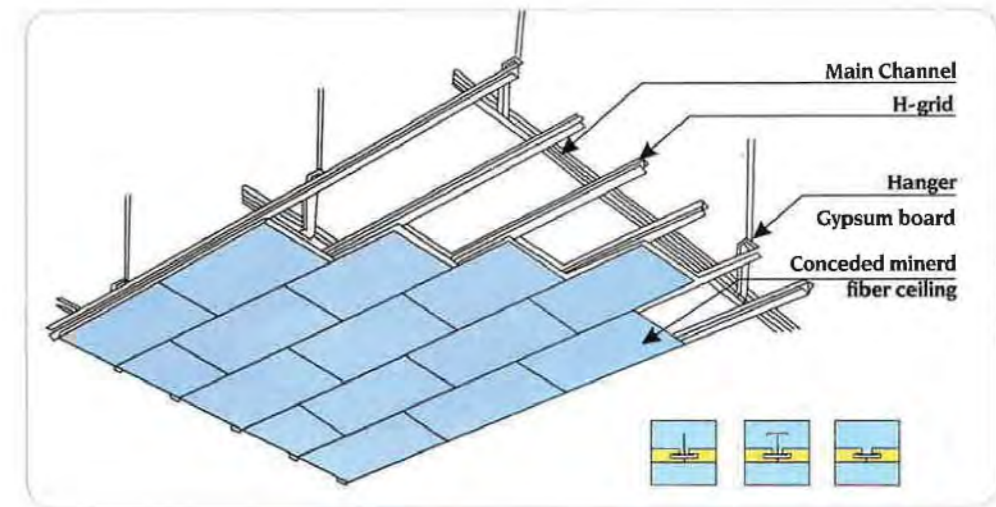
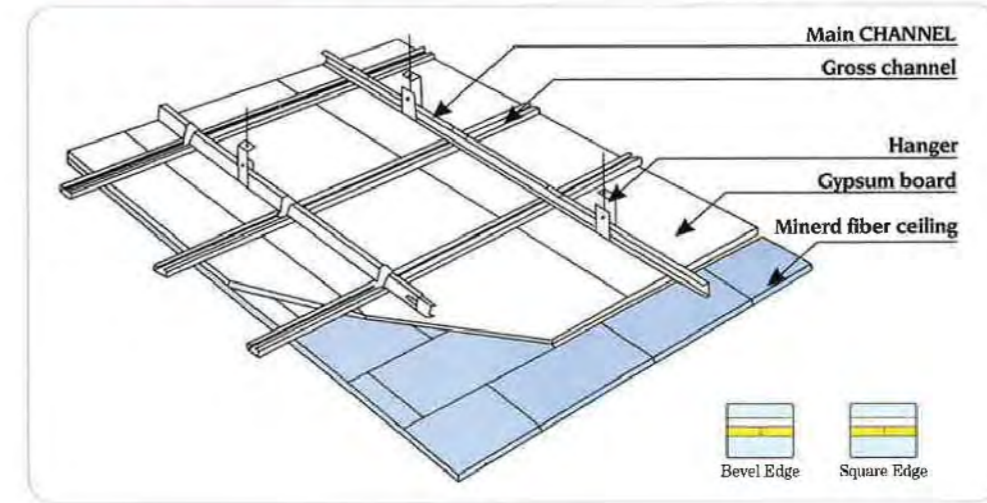

Installation of Partition System

Calcium Silicate Board System

Installation of Partition System



Installation of Ceiling System

Calcium Silicate Board System

Installation of Ceiling System



Advantages:

Calcium silicate board is a new green building material. With silicate and calcium materials as base and wood fiber as strengthen, which has the advantage of high strength, anti freeze, water-resist, fire-proof, damp-proof, sound-absorption, no distortion and no radiation...etc.

Features

Length: 2440mm or 595mm or 600mm or 603mm

Width: 1220mm or 595mm or 600mm or 603mm

Thickness: 4-30mm or 4-6mm

Materials: Tobermorite, Cao, Quartz sand, reinforced wood fiber

Application:

Interior and Exterior wall partition, suspended ceiling, fireproof board.

Also can be used for: Commercial and industrial construction, residential building, movie theaters, exhibition halls, restaurants, hotels, hospitals, tran station or MRT stations and so on.

Mineral Fiber Ceiling Tiles



MFCT-SH01

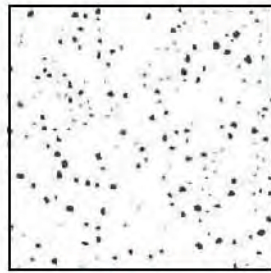

MFCT-SH02

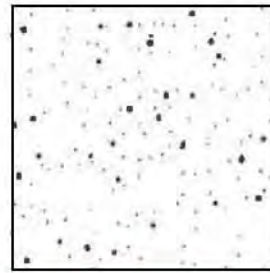

MFCT-SH03

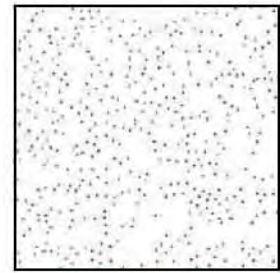

MFCT-SH04

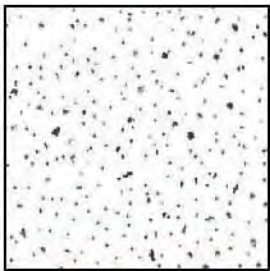

MFCT-SH05

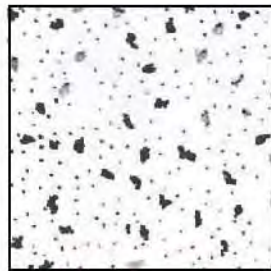

MFCT-SH06



MFCT-SH07

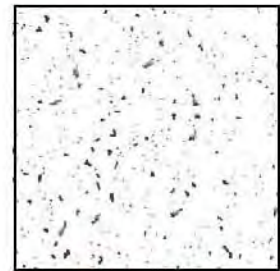

MFCT-SH08

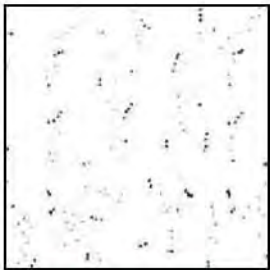

MFCT-SH09

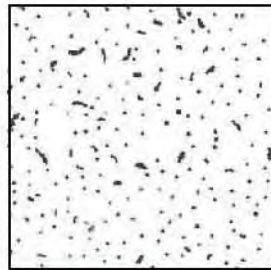

MFCT-SH10

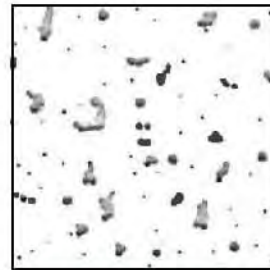

MFCT-SH11

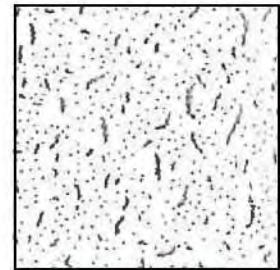

MFCT-SH12

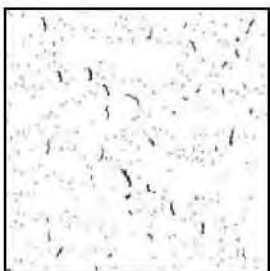

MFCT-SH13



MFCT-SH14



MFCT-SH15

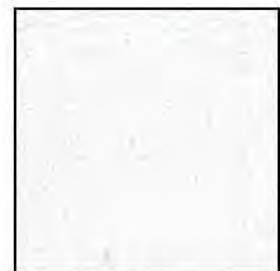

MFCT-SH16

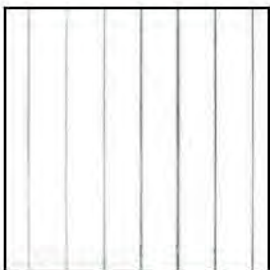

MFCT-SH17

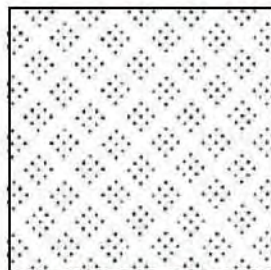

MFCT-SH18

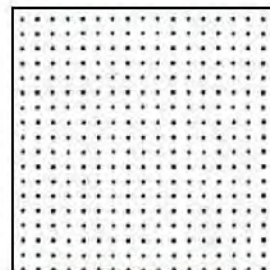

MFCT-SH19

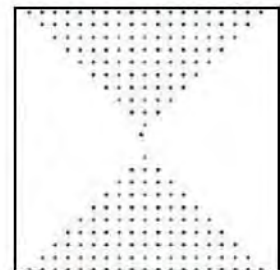

MFCT-SH20

Ceiling

Mineral Fiber Ceiling Tiles

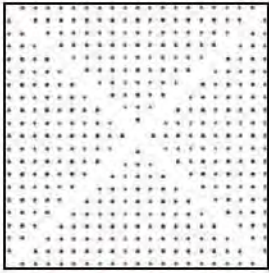

MFCT-SH21

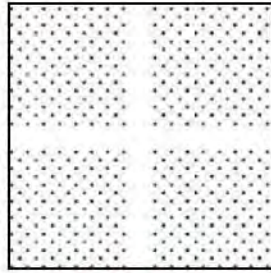

MFCT-SH22

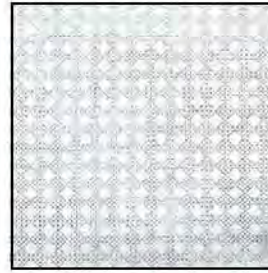

MFCT-SH23

T Grid Suspension System for Mineral Fiber Tile



32H Flat T-Grid:
 32 x 24 x 3600 / 3660mm
 26 x 24 x 1200 / 1220mm
 26 x 24 x 600 / 610mm
38H Flat T-Grid:
 38 x 24 x 3600 / 3660mm
 26 x 24 x 1200 / 1220mm
 26 x 24 x 600 / 610mm



32H Black Gloove:
 32 x 16 x 3600 / 3660mm
 32 x 16 x 1200 / 1220mm
 32 x 16 x 600 / 610mm
38H Black Gloove:
 38 x 16 x 3600 / 3660mm
 38 x 16 x 1200 / 1220mm
 38 x 16 x 600 / 610mm
42H Black Gloove:
 42 x 16 x 3600 / 3660mm
 42 x 16 x 1200 / 1220mm
 42 x 16 x 600 / 610mm



32H Narrow T-Grid:
 32 x 15 x 3600 / 3660mm
 32 x 15 x 1200 / 1220mm
 32 x 15 x 600 / 610mm
38H Narrow T-Grid:
 38 x 15 x 3600 / 3660mm
 38 x 15 x 1200 / 1220mm
 38 x 15 x 600 / 610mm



Langle:
 20 x 20mm
 24 x 24mm
 20 x 14.5mm
 20 x 16mm
Wangle:
 10 x 10 x 10 x 15mm
 15 x 10 x 10 x 20mm
 19 x 19 x 13 x 24mm



30H Black Line:
 30 x 24 x 3600 / 3660mm
 30 x 24 x 1200 / 1220mm
 30 x 24 x 600 / 610mm



32H White Line:
 32 x 14.5 x 3600 / 3660mm
 32 x 14.5 x 1200 / 1220mm
 32 x 14.5 x 600 / 610mm



Alloy Lock



Fire-Proof Hole

Aluminium Ceiling Tiles

The silvery sheen of aluminum can help brighten up any room, particularly when it is used on the ceiling to provide a place to draw the eye and reflect ambient illumination. One of the best ways to decorate a ceiling with aluminum and achieve the aforementioned look is to install aluminum ceiling tiles that have been shaped to enhance the décor of almost any setting. Here at Decorative Ceiling Tiles, you can find all of the aluminum tiles that you need for your home, office, or commercial establishment.



Cloudy
ACT-SH01

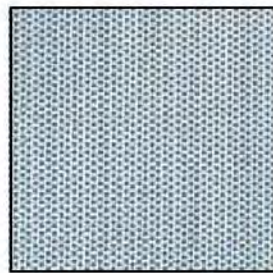

Perforated
ACT-SH02

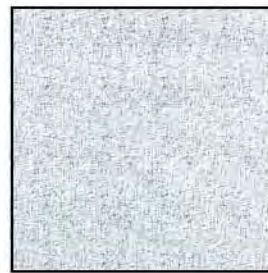

White
ACT-SH03



Mirror
ACT-SH04

Ceiling



Ceiling

Gypsum Boards

The Application of Drywall System

Main Advantages

1. Fire Proof:

Fire Proof Gypsum Board was tested by the National Center for Quality Supervision. It is designed for fire insulation up to 1-3 hours.

2. Moisture / Water Proof

Moisture / Water Proof Board is excellent in Moisture / Water resistance. It is made from extra tough paper mixed with wax, and the compound of gypsum board has silicone which reduces moisture absorption of the board.

3. Heat Insulation

Gypsum Board has heat prevention material incorporated, it has great feature of heat prevention. Thermal resistance is 1.14m²k/w

4. Sound Insulation

Gypsum Board proved to have good noise insulation property after inspected by the National Center for Quality Supervision and Testing of Fire Building Material (NFTC), The noise insulation factor of the wall can reach 44dB and 47dB. It has the best noise insulation constitution in China, especially the 95mm wall comprised by the 10mm board.

5. Commercial Building Material

Gypsum Board is ideal for ceiling and single layer partition in residential and commercial building. It can save time, space, and expense. It is a new and high efficient wall.

Specifi Cation

Wall: Width x Length 2400 x 1200(mm)

Thickness: 6-12(mm)

Ceiling: Width x Length 2400 x 1200 or 600 x 600(mm)

Thickness: 5-6(mm)



Gypsum Boards

The Application of Drywall System

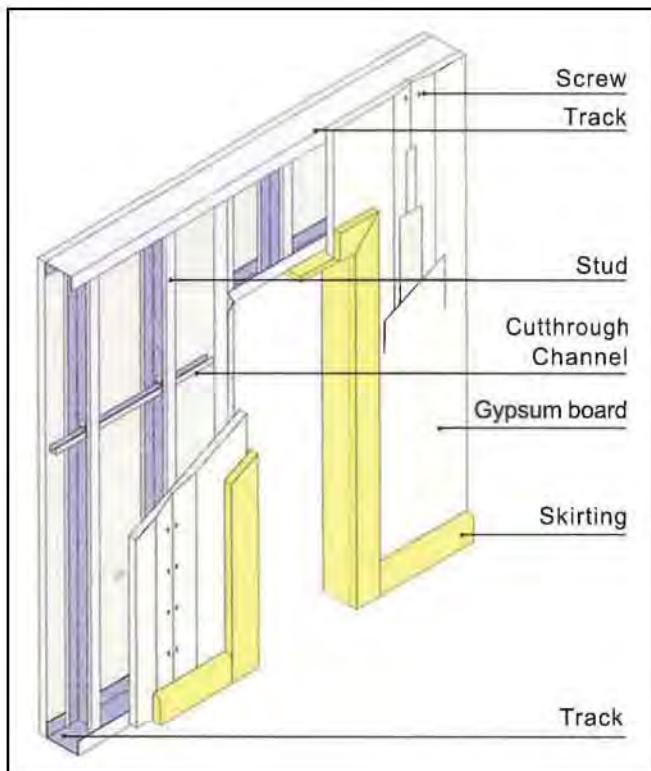
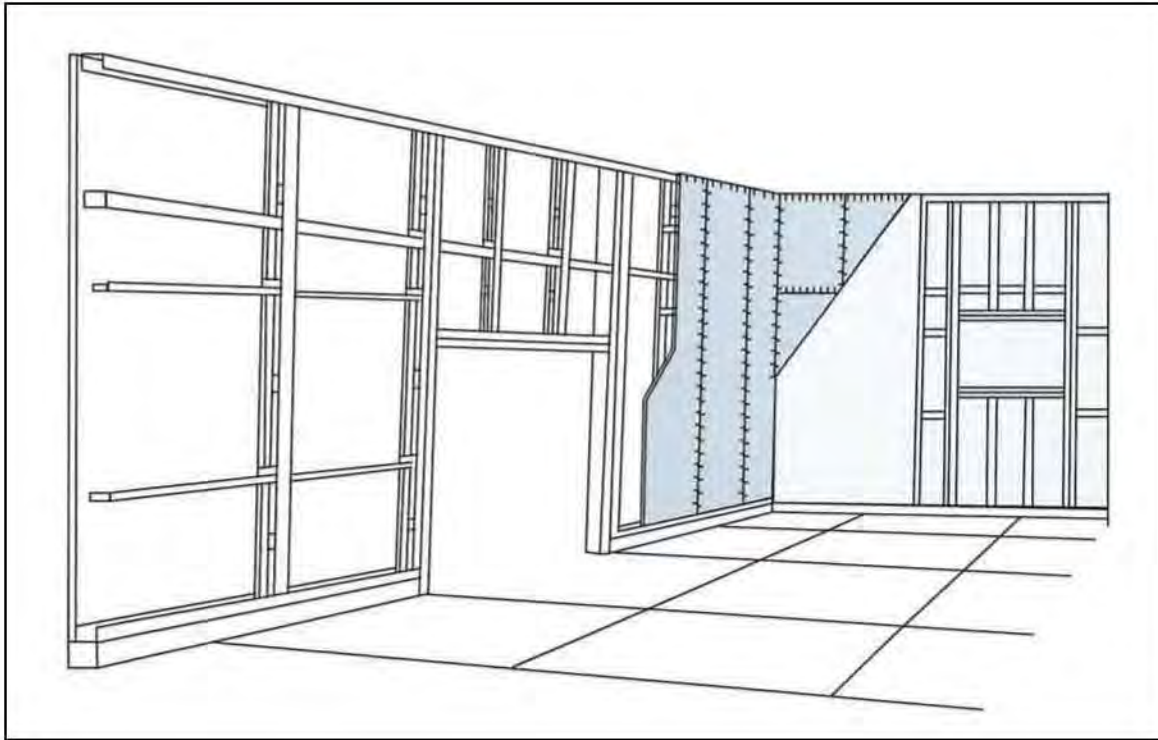

1. Draw the installation guideline.
2. Use the shooting nail or expansion bolt to fix keel on the ceiling and floor.
3. And arrange the vertical keel as per the request and install the horizontal keel.

■ Fixing method of the board

1. To cut the board as per the required size.
2. The boards should be fixed on the keels by the tapping screws in seam misplacement form, the distance between tapping screws is 250mm. And each screw head should enter 0.5m depth into the board.
3. Please leave a seam between boards about 2 mm width.
4. When fixing the board, it should be mounted from its center to the edges. Don't fix it at different points at the same time avoid the over bending of the board.

Ceiling

Gypsum Boards

Gypsum Board Description

Gypsum Board is used natural gypsum powder through special treatment then together with high quality face paper as made.

Function:

1. Interior wall and partition
2. For ceiling system
3. Sound-adsorbing wall body
4. Fire-proof
5. Damp-proof
6. Durability and long service life
7. High strength
8. Good heat and sound insulation

Specifications: 1220mm × 2440mm; 1200mm × 2400mm; 3000mm × 1200mm; 2500mm × 1200mm;
Thickness: 7mm-15mm. Other optional specifications available

Standard Specification: Products meet national standards of China, ISO gypsum board standard and the CE standards.

Beside, we also do the customers-made according to your special requirements.

ITEM	EDGE	LENGTH	WIDTH	THICKNESS
PLASTERBOARD	TAPERED SQUARE	2400	1200	9.5
		2440	1200	12.0
		2700		12.5
		3000		12.7
		3600		15.0
		3660		15.9

THICKNESS	LOAD BREAKING STRENGTH		REMARKS COLUMN:NON-NATIONAL STANDARD PRODUCTS, AND RELEVANT DATA CAN BE FOUND THROUGH ASTM C13960-04, BS1230 AND ISO6308 STANDARDS DOCUMENTS.
	VERTICAL	HORIZONTAL	
9.5	360	140	
12.0	500	180	
15.0	650	220	



Gypsum Boards

Calcium Silicate Board System

Installation of Partition System

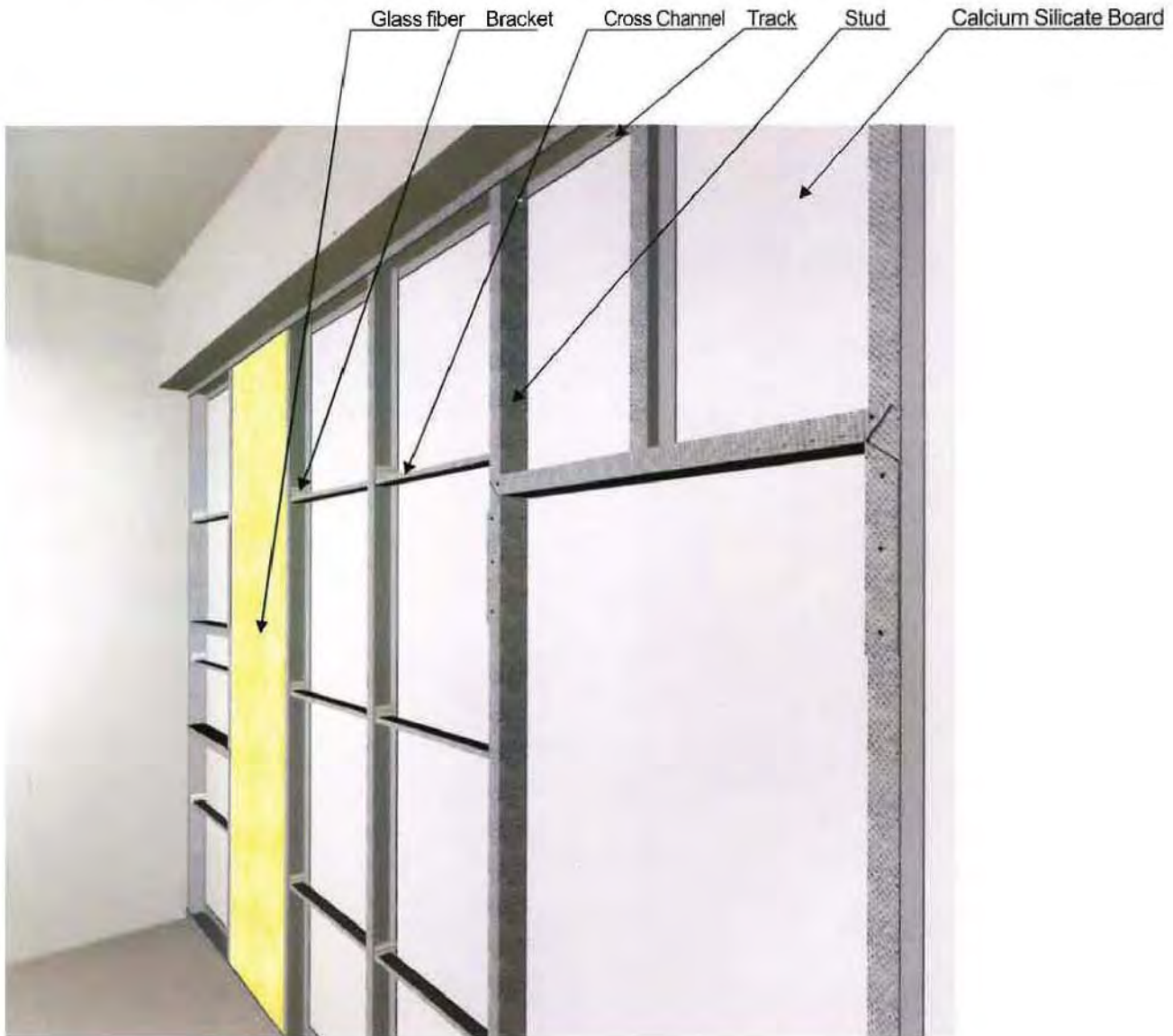

Ceiling

Gypsum Boards

Calcium Silicate Board System

Installation of Ceiling System



Advantages:

Calcium silicate board is a new green building material. With silicate and calcium materials as base and wood fiber as strengthen, which has the advantage of high strength, anti freeze, water-resist, fire-proof, damp-proof, sound-absorption, no distortion and no radiation...etc.

Features

Length: 2440mm or 595mm or 600mm or 603mm

Width: 1220mm or 595mm or 600mm or 603mm

Thickness: 4-30mm or 4-6mm

Materials: Tobermorite, Cao, Quartz sand, reinforced wood fiber

Application:

Interior and Exterior wall partition, suspended ceiling, fireproof board.

Also can be used for: Commercial and industrial construction, residential building, movie theaters, exhibition halls, restaurants, hotels, hospitals, tran station or MRT stations and so on.

Gypsum Boards

Gypsum Board & Calcium Silicate Board Accessories



Glass Fiber Mesh

Specifications:

- A. Mesh size: 2.85 × 2.85mm, 4 × 4mm, 4 × 5mm, 5 × 5mm, 10 × 10mm
- B. Weight per unit area: 50~300g/m²
- C. Width: 1~1.2m
- D. Length: 50M or 100M
- E. Color: white, orange, blue, etc.



Metal Corner Tape

Specifications:

1. size: 50mm × 30m
2. Application: use in a variety of drywall applications: Internal or external corners which are 90 degrees or not 90 degrees, for manual application only.



Interior Wall Putty

Feature:

1. Containing no toxic substances, healthy
2. Easily available and efficient to apply it on the wall directly
3. No wastage of water curing
4. Free from shrinking and cracking
5. Ensures full strength on setting
6. Shows excellent adhesive qualities with the surface
7. Has a good impact strength

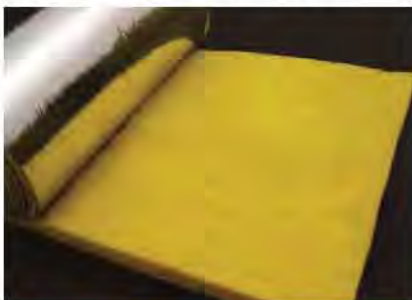

Fiber Glass Blanket

Specifications:

1. Heat Insulation Materials
2. Average diameter of fibers: 7 um
3. Density: 10kg/m² ~ 25kg/m²
4. Thickness: 20mm ~ 100mm
5. Width: 900mm ~ 1200mm
6. Length: 5m ~ 30m



Screw

Specifications:

1. Product: Gypsum board screw
2. Material: Carbon steel
3. Finish: black phosphated / galvanized
4. Size: #6 × 25mm

Suspension System



Furring channel & main channel



Stud & Track



Clip in channel



DC60 & DU28



Australian channel



Stud 63 & track 64



Accessory



Structure channel

Ceiling

Installation of Ceiling

The Application of Ceiling System

Installation Methods:

1. We draw the installation guideline to define the fixing position, the center distance is 1200mm.
2. Use UC type keel hang fitting to link and fix the boom and key keel, keep the key keel horizontal.
3. Use the capliper to vertically fix the sub keel on key keel, the center distance of the sub keels is 611 m.
4. To install the horizontal keels as per the request, is center distance is 1222mm.
5. Use the tapping screw fix the fire-board on the sub-keel and do the treatment of the seam connection.

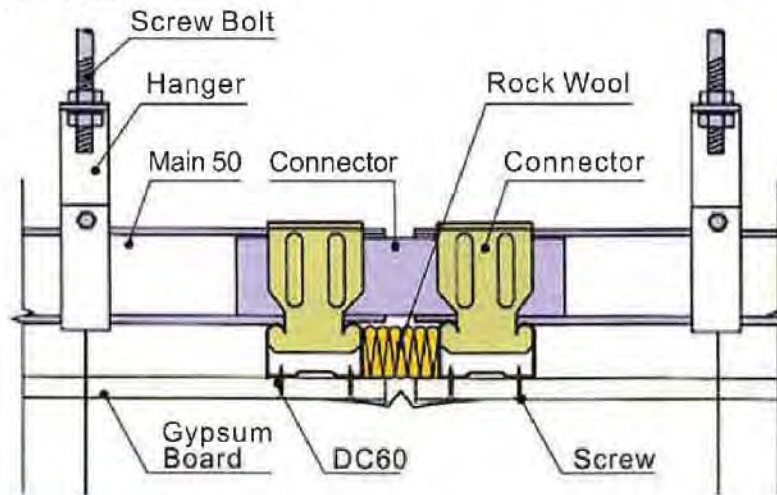

G.I. Drywall for Ceiling

Photo	Sectional view	Item	W	H
P1		V channel		30 /38
P2		main channel	38	10 /12 /14
P3		main channel	50	12 /15
P4		cross channel	50	15 /17 /19
P5		cross channel	60	27
P6		U angle	29	24 /29
P7		main channel	21	26
P8		cross channel	38	27

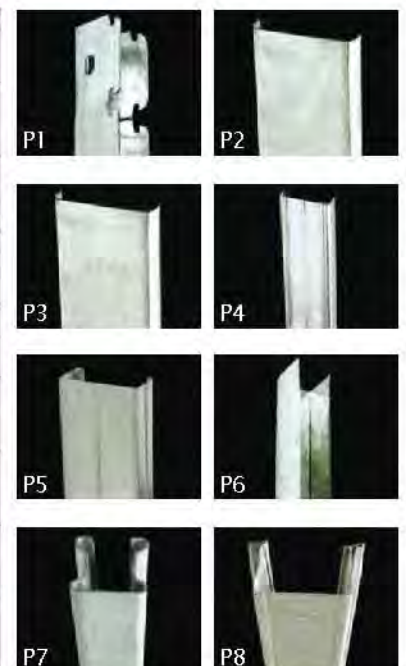

Installation of Ceiling

G.I. Drywall for Ceiling

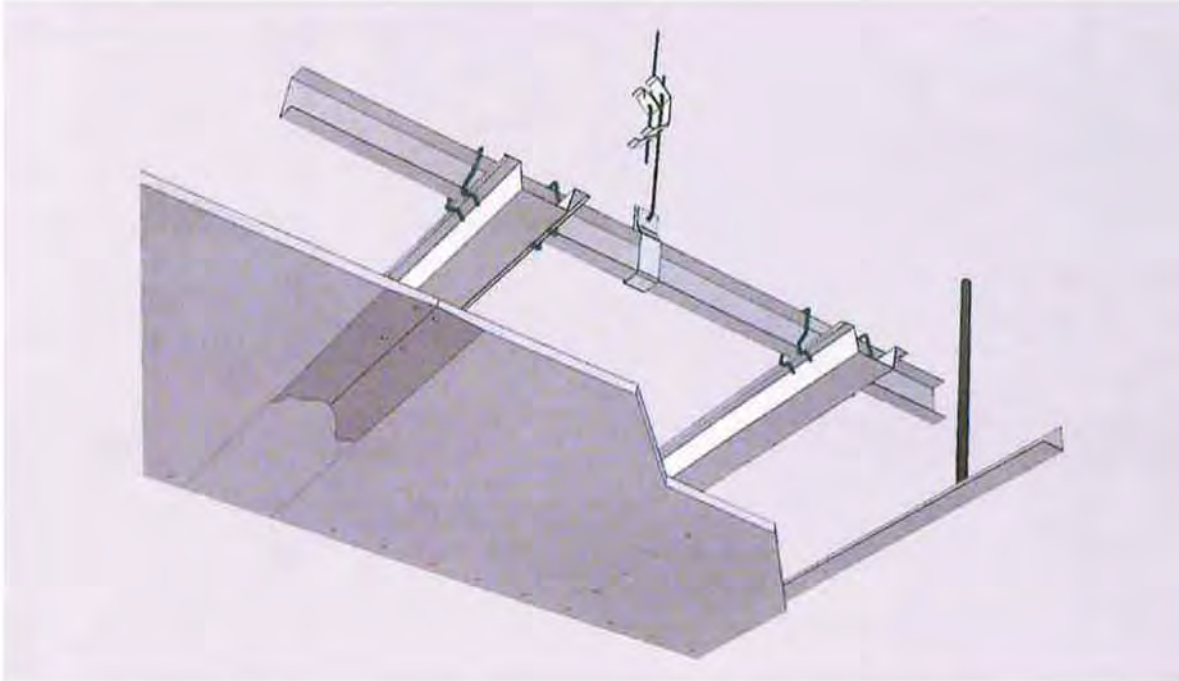

Ceiling

Photo	Sectional view	Item	W	H
P1		Main channel	38	
P2		Furring channel		
P3		L Angle	22-35	
P4		Wire Clip	22-35	

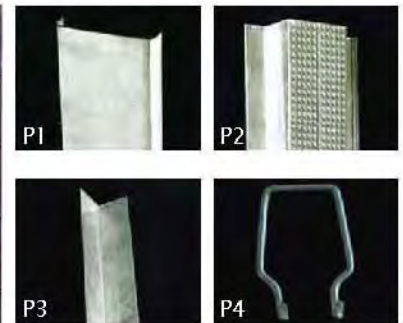

Installation of V channel with cross channel 50

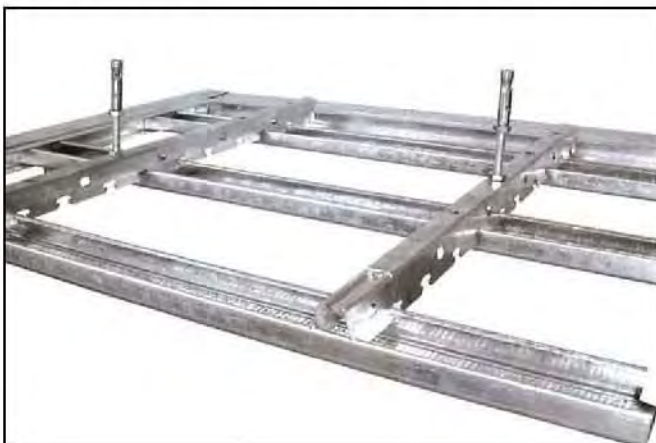

Installation of cross channel 60

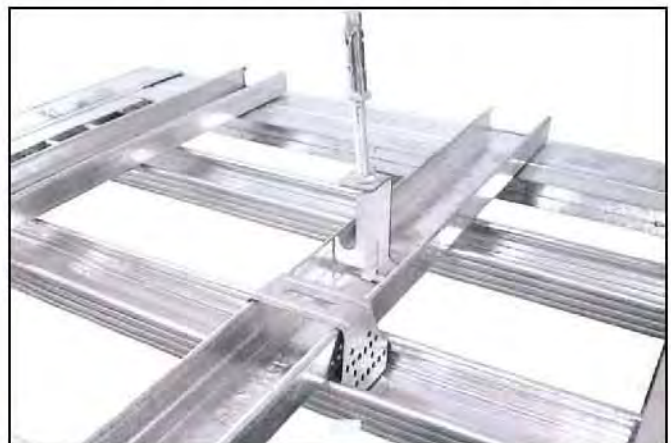

Ceiling

Installation of Ceiling

G.I. Drywall for Ceiling

Illustration of installation

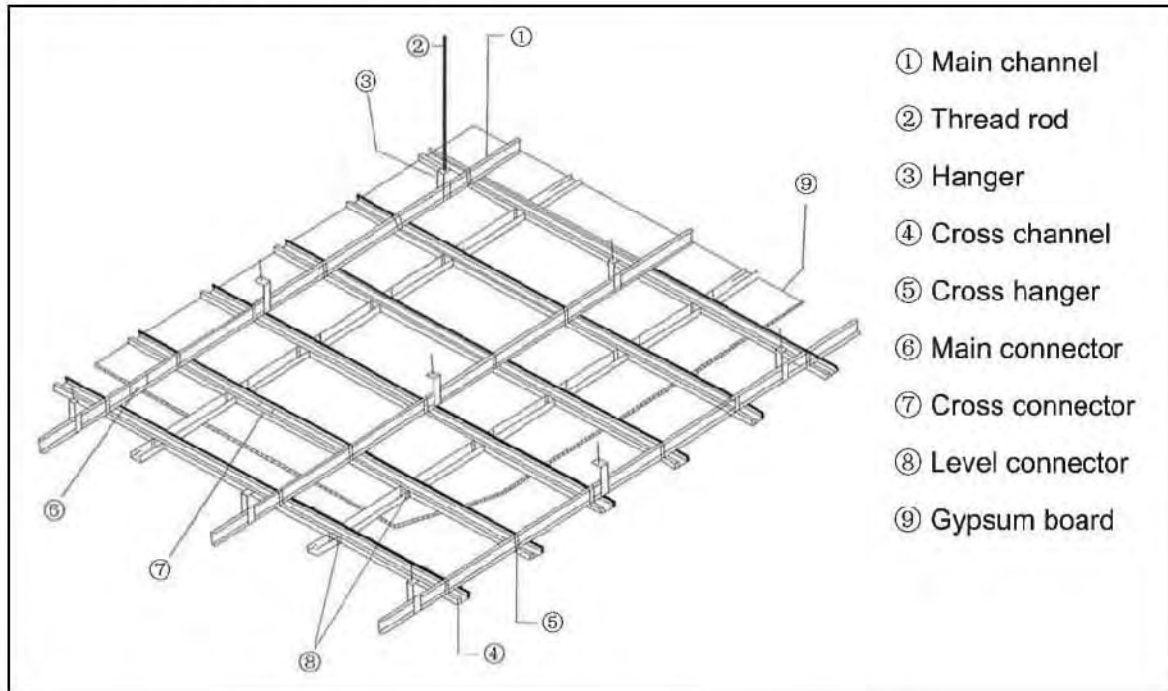

Installation of main channel with cross channel 50

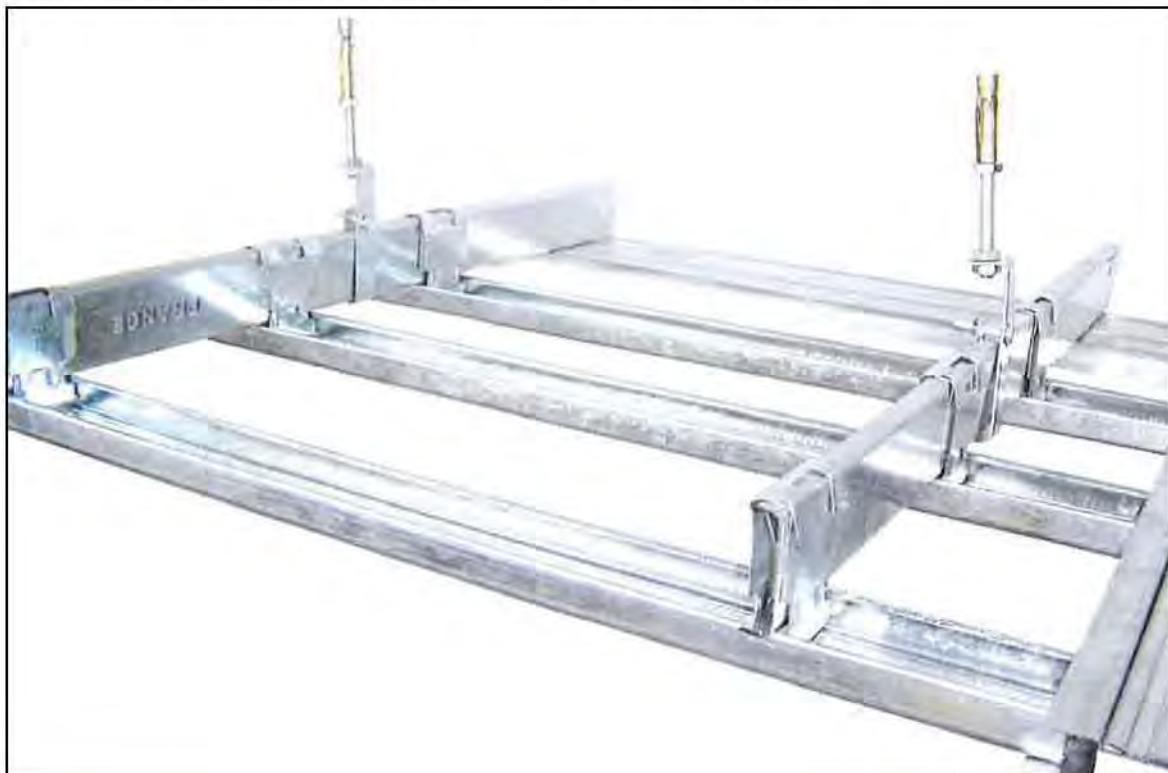

Installation of Ceiling

G.I. Drywall for Wall Partition

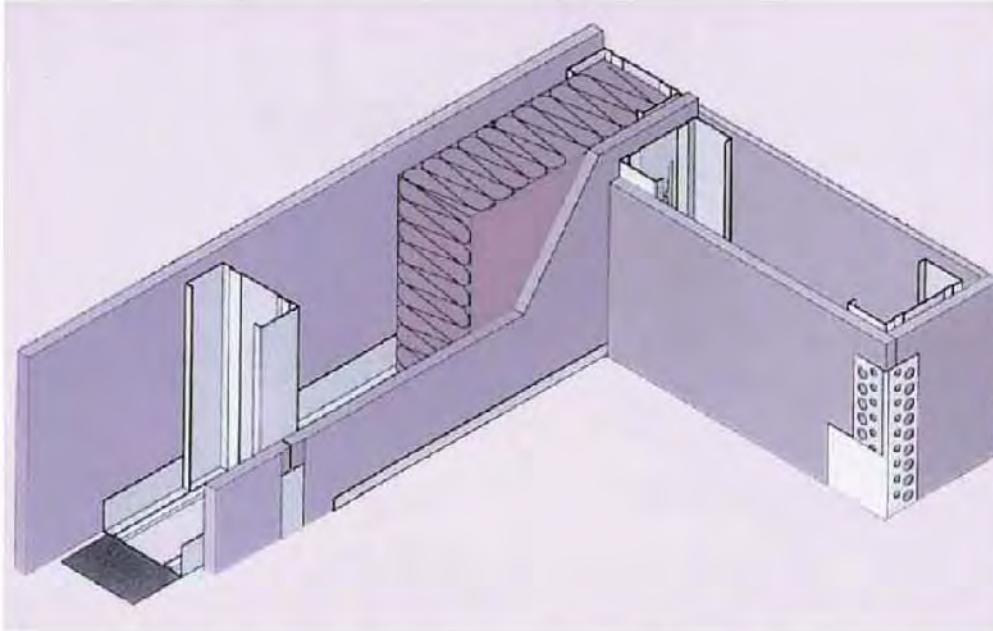

Ceiling

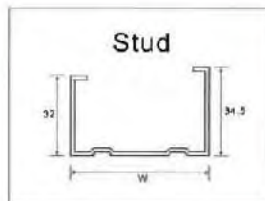

Specification(mm)

W
50
70
73
98
146

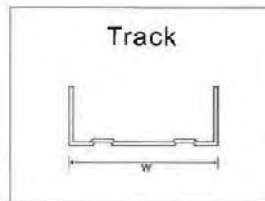

Specification(mm)

W
52
72
75
100
148

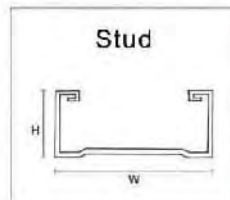

Specification(mm)

Item	W	H
stud 50	50	35 /48
stud 63	63	30 /31 /35
stud 75	75	30 /40 /48
stud 100	100	48
stud 150	150	48

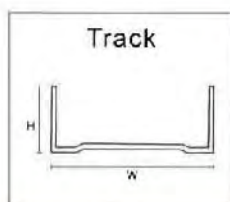

Specification(mm)

Item	W	H
stud 50	50	
stud 63	63	
stud 75	75	
stud 100	100	
stud 50	150	



Ceiling

Gypsum Ceiling & Partition Accessories

Australia G.I. System



SH394



Corner Angle



SHD50



SH2534



SH140



Beta-Fix



G Channel



SH308



SH310



Gypsum Ceiling & Partition Accessories

Accessory for G.I. Drywall



SH1-Hanger



SH2-Main Connector



SH3-Cross Connector



SH4-Cross Hanger



SH5-Level Connector



SH6-Hanger - Cross Connector



SH7-Level Connector



SH8-Hanger



SH9-Hanger



SH10-Connector



SH11-Suspension Bracket



SH12-Corner Angle

Ceiling

Gypsum Ceiling Tiles Accessories

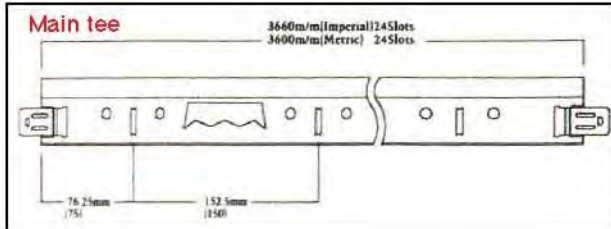

Main Tee
(Size: 0.6 Mtr. & 1.2 Mtr.)
Available in Normal = 32mm
Heave Duty = 38mm

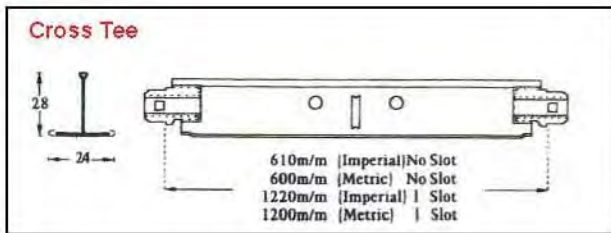

Cross Tee
(Size: 0.6 Mtr. & 1.2 Mtr.)

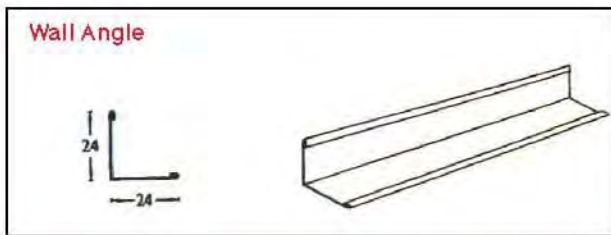

Wall Angle
(Size: 3.0 Mtr. & 3.5 Mtr.)

Bruserstang Crown Tee Grid Suspension System
Are Specially Design For Fire Retardant Properties

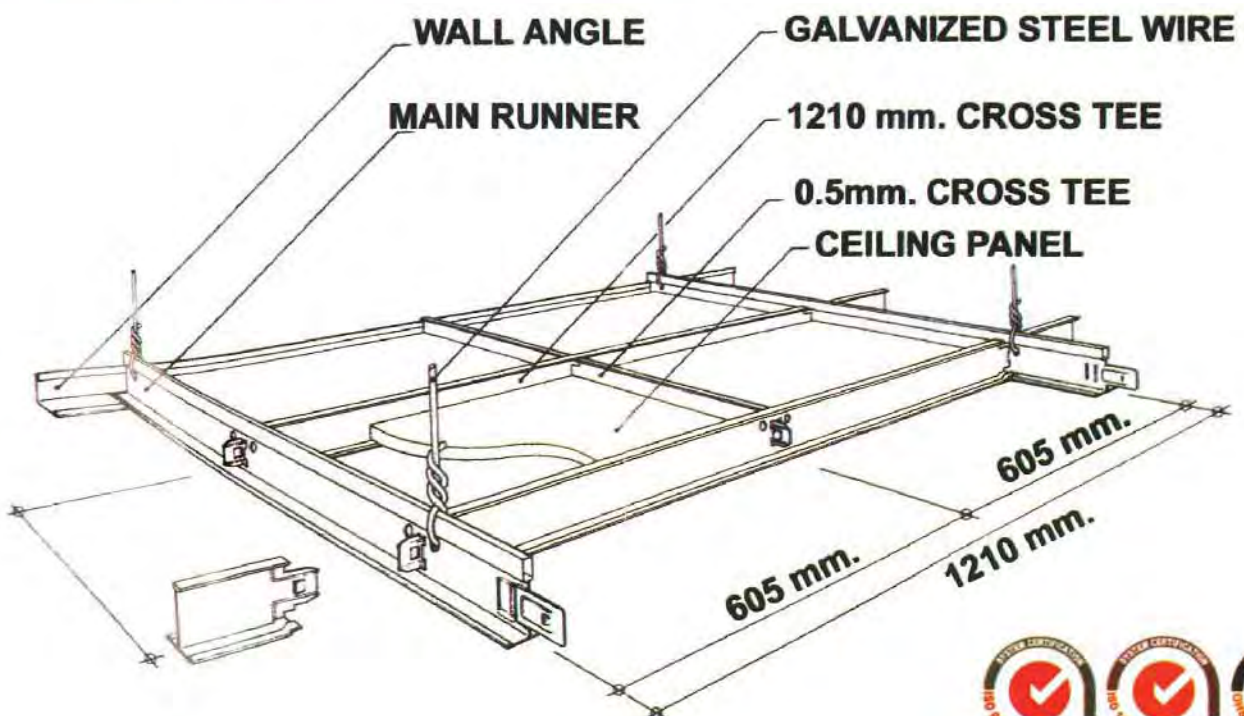

Aluminium Ceiling Accessories



Spring 'T'

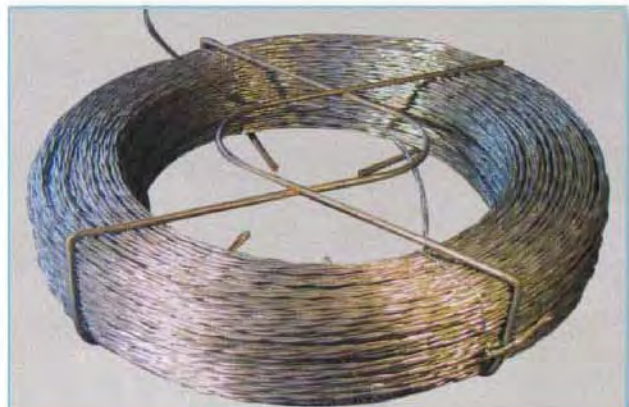

Twisted Wire



Holders



Edge Trim



ROD

HANGER

CONNECTOR



LOUVER LIGHT

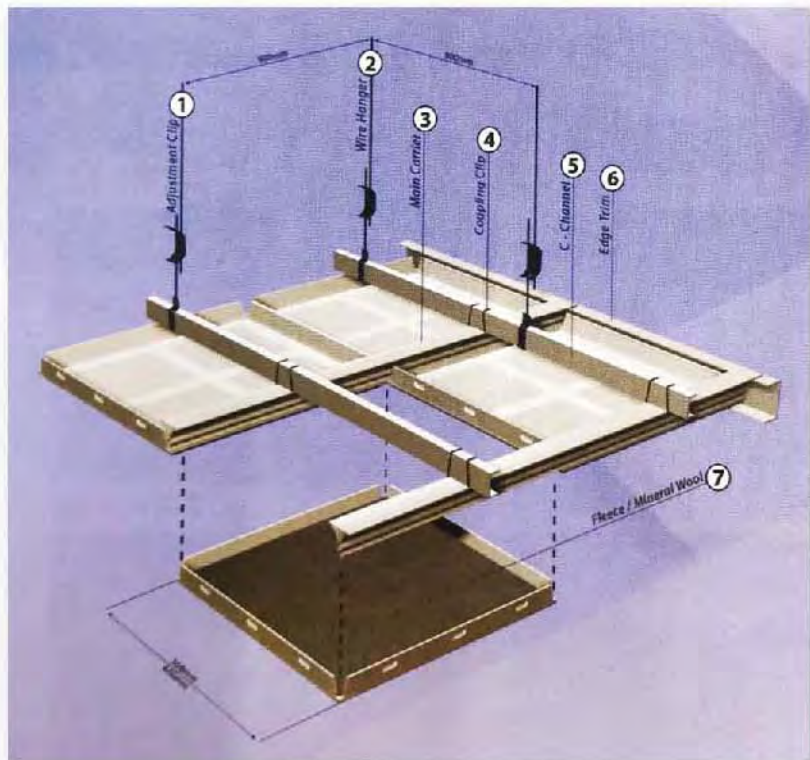

Hardware

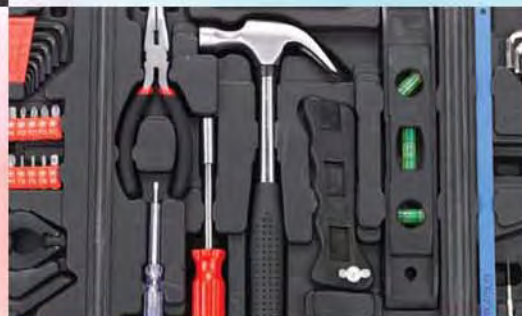
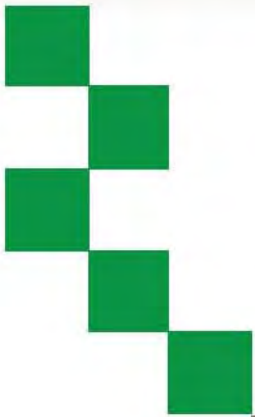

- Screws & Nails
- Adhesives
- Glass Blocks
- Tools

Screws & Nails



Stainless Steel Nails
 Size: 2.5mm x 25mm
 3.0mm x 40mm
 3.0mm x 50mm
 3.0mm x 60mm
 3.0mm x 70mm
 4.0mm x 110mm

SIZE FINE & COARSE	
3/4 x 6	1 x 8
1 x 6	1 1/4 x 8
1 1/4 x 6	1 1/2 x 8
1 1/2 x 6	2 x 8
2 x 6	2 1/2 x 8
2 1/2 x 6	
3 x 8	
4 x 10	

WIRE NAILS	SIZE L.H NAILS	STEEL NAILS
1"	1/2"	1"
1 1/4"	3/4"	1 1/4"
1 1/2"	1"	1 1/2"
2"	1 1/4"	2"
2 1/2"	1 1/2"	2 1/2"
3"	2"	3"
4"		4"



BULKED NAIL(50LB)

Size	Finish	Shank
1" x .120	White Galvanized	Smooth Shank
1 1/4" x .120	White Galvanized	Smooth Shank
1 1/2" x .120	White Galvanized	Smooth Shank
1 3/4" x .120	White Galvanized	Smooth Shank
2" x .120	White Galvanized	Smooth Shank
2 1/2" x .120	White Galvanized	Smooth Shank
3" x .120	White Galvanized	Smooth Shank

ROOFING NAILS (UMBRELLA HEAD)

Size	Finish	Shank
8BWGX1.5	White Galvanized	Smooth
8BWGX2	White Galvanized	Twisted/Smooth
8BWGX2.5	White Galvanized	Twisted/Smooth
8BWGX3	White Galvanized	Twisted/Smooth
8BWGX4	White Galvanized	Twisted/Smooth
9BWGX1.5	White Galvanized	Twisted/Smooth
9BWGX2	White Galvanized	Twisted/Smooth
9BWGX2.5	White Galvanized	Twisted/Smooth
9BWGX3	White Galvanized	Twisted/Smooth
10BWGX1.75	White Galvanized	Twisted/Smooth
10BWGX2	White Galvanized	Twisted/Smooth
10BWGX2.5	White Galvanized	Twisted/Smooth
10BWGX3	White Galvanized	Twisted/Smooth



Adhesives

Product: Good Quality Spray Glue

Model No: 608#

Bonding Material:

- Sponge, foam, wood, fabric, non-woven, paper, plastic, wood etc, used for sofa, chairs, mattress industry

Product information:

- Implementary Standard: GB18583-2001
- G.W: 15kgs/Tin
- N.W: 14kgs/Tin
- 1' x 20' Container can load 1242 Tin
- Spec: - Main ingredients: Synthetic Rubber, Savage Resin
 - Viscosity CP.S(25°C): 65±10
 - Heat & Aging Resistance: Average
 - Volatilization Time(s): 30-50s
 - Opening Time(minute): 6-8mins
 - Best Time for Conglutination: 1-3mins
- Applicable Material: Suitable for large area bonding between materials as foam, sponges, fabric, clothes, wood, spray-gel, floss, boards, and other multi-aperture



Product: Super All-Purpose Contact Glue

(for brushing and scratching operation)

Model No: 828B#

Bonding Material:

- wooden furniture, board furniture, all-purpose, bond fireproof board, PVC, aluminium board, both thin and thick board, metal, EVA etc, used for board furniture and kitchenware

Product information:

- Capacity: 20litre / Net Weight: 15kgs
- Color: Yellow
- Spec: - Initial Viscidity: 0.7Mpa
 - Shear Strength: 1.3Mpa
 - Viscosity: 3000±300Cps
 - Density: 0.93KG/L
 - Solid Content: >23%
 - Temperature Durability: up to 120 degree cel.
 - Chloroprene Rubber: 20-30%
 - Opening Time(minute): 30mins-1hr
 - Hydrocarbon & Solven: 10-15% & 50-60%
 - Other Additives: 10-15%
 - Packing: Metal Tin and Strong Outer



Glass Blocks

For Furniture, Architecture & Interior Design

Size: 190mm x 190mm x 80mm
Fire Rating: 45 minutes



Clear Ice
GB-SH01



Blue Cloudy
GB-SH02



Clear Jewel
GB-SH03



Clear Parallel
GB-SH04



Pink Cloudy
GB-SH05



Misty Cloudy
GB-SH06



Misty Brown
GB-SH07



Green Cloudy
GB-SH08

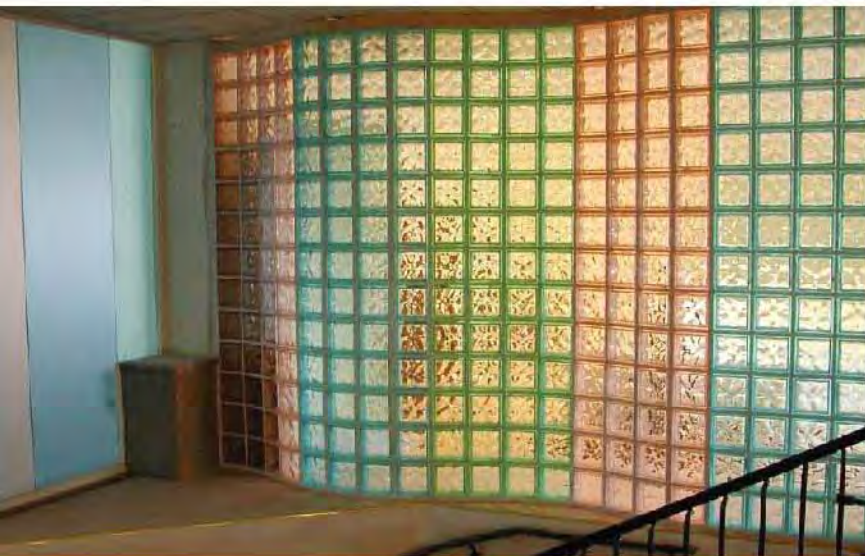

Hardware

Tools



Professional Tool Set



SR9101



SR9106



SR9234



SR9236



SR9252



Glass

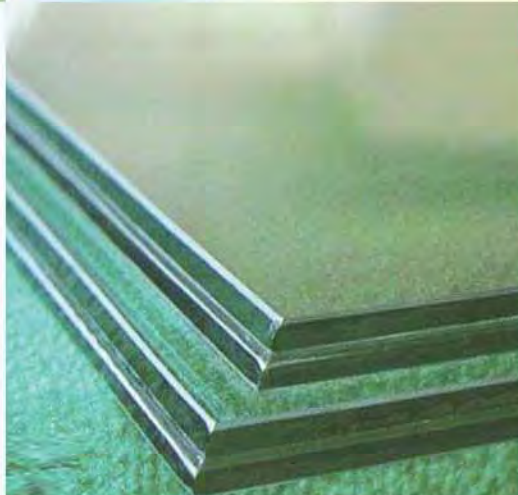
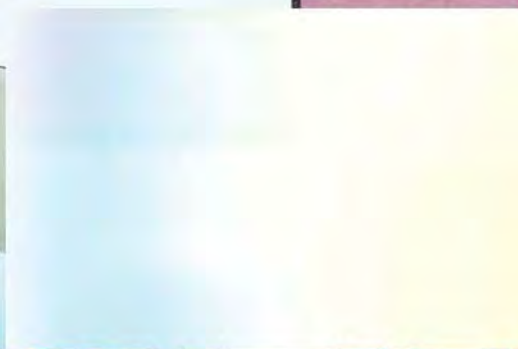
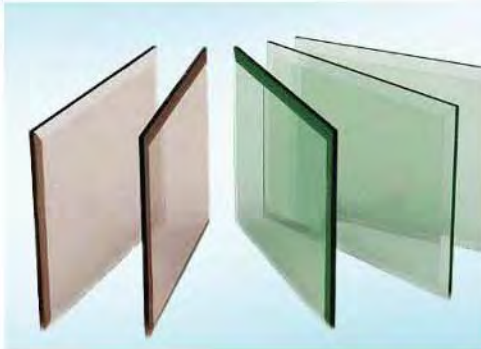
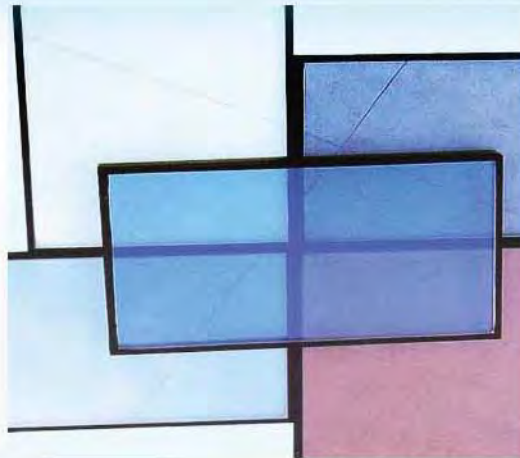

- Clear Float Glass
- Low Iron Glass
- Tinted Glass
- Reflective Glass
- Low Emissivity Glass
- Laminated Glass
- Silver Mirror
- Aluminum Mirror



Clear Float Glass

Clear Float Glass is made by high-quality sand, natural ores and chemical materials by mixing them and melting them at high temperature. The molten glass flows into a tin bath where the float glass is spread, polished and formed on the molten tin. The float glass has a smooth surface, excellent optical performance, stable chemical capability, and high mechanical intensity. It is also resistant to acid, alkali and corrosion.

Features:

- High light transmittance, excellent optical performance
- Smooth and flat surface, visible flaw is controlled strictly
- Easily to be cut, insulated, acid-etched, lacquered, tempered and coated.
- Thickness available from 0.8mm to 22mm

Application:

- Windows, doors and facades on various buildings
- Interior applications for furniture or decorations
- Mirror making
- Automotive window shields
- Instruments

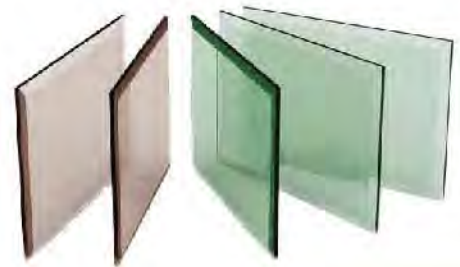

Standard:

China GB11614-2009, Europe EN 572, and Russia GOST 111-2001

Specification:

Normal Thickness: 3mm, 4mm, 5mm, 5.5mm, 6mm, 8mm, 10mm, 12mm,
Ultra Thin: 0.8mm, 1.0mm, 1.3mm, 1.5mm, 1.8mm and 2mm, etc.

Ultra Thick: 15mm, 19mm, 22mm

Sizes: 1524x2134mm, 1220x1830mm, 1650x2140mm, 1830x2440mm,
2134x3300mm, 2250x3300mm, 2440x3300mm, 2140x2660mm,
2440x3660mm, etc. can be produced according to client's request.



Low Iron Glass

Low Iron Glass is a kind of plate glass with highly clear, highly transmissive, highly smooth. And it is a new type of deeply processed glass, also it is a new type advanced structural glass with environment protection. The glass is a lower iron float glass and be made by a special process. It is not like the clear float glass to sight like green, it looks just like colorless crystal, highly transmissive and terrific.

Features:

- Excellent clarity ensures true colors are seen and optimum vision quality is achieved when looking through the glass.
- Offers a high level of light transmittance
- Creates maximum light inside rooms due to the products high level of transparency.
- Particularly beneficial for thicker laminated products, affording a high level of transparency.
- The edges of the glass remain white, unlike other glass making it ideal for use in furniture.

Application:

- Display cabinets
- Shelves
- Glass furniture
- Table tops, bars and desk tops
- Shower screens
- Solar energy industries

Standard:

China GB11614-2009, Europe EN 572, and Russia GOST 111-2001

Specification:

Thickness: 3mm, 3.2mm, 4mm, 5mm, 6mm, 8mm, 10mm, 12mm, 15mm, 19mm, etc.

Sizes: 1830x2440mm, 2134x3300mm, 2134x3660mm, 2250x3300mm, 2250x3660mm, 2440x3660mm, etc. maximum 3660x8000mm

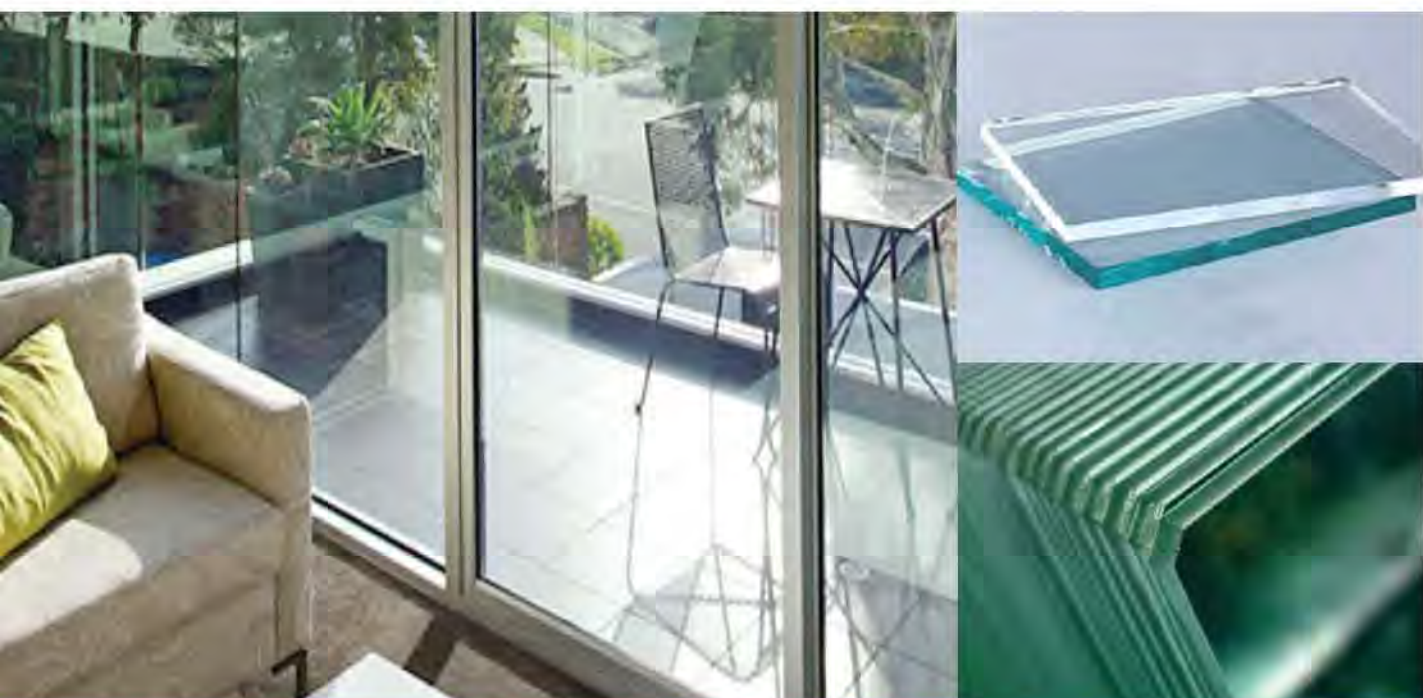

Tinted Glass

Tinted Glass is produced by the float process with the addition of small quantities of metal oxides to color the normal clear glass mix. This coloration is achieved through adding metal oxides at the smelting stage. Addition of color does not affect the basic properties of the glass, even though visible light reflectance will be slightly higher than clear glass.

Features:

- The body tinted float glass can reduce transmission of the sun's harmful rays by up to 80% thus minimizing fading to interior furnishings.
- The comprehensive range of soft natural colors compliments and harmonizes with modern building materials to provide an exciting and different look to new or existing buildings.
- Could be easily cut, bent, insulated, laminated, lacquered, coated, tempered or heat strengthened and in addition can be silk-screened.

Application:

- Commercial and civil buildings
- Interior decoration and show windows
- Automotive window shield

Standard:

China GB/T 18701-2002, Europe EN 572 part 2 1995

Specification:

Colors: Bronze, Dark Bronze, Euro Grey, Blue Grey, Dark Grey, French Green, Dark Green, Ford Blue, Dark Blue, Ocean Blue, Pink, etc.

Thickness: 3mm, 4mm, 5mm, 5.5mm, 6mm, 8mm, 10mm, 12mm, etc.

Sizes: 1524x2134mm, 1650x2140mm, 2140x3300mm, 2250x3210mm, 2250x3300mm, 2440x3300mm and 2140x3660mm, etc.



Reflective Glass

Coated glass is also called heat reflective glass, which coated a kind of metal oxide on the surface of glass by physical or chemical method to make it has a high reflective ability to the sunlight, meanwhile it still has good transmission of light.

Features:

- High wear and scratch
- High reflectivity for infrared
- Low transmittance for ultraviolet ray

Application:

- Offices
- Commercial buildings
- Schools
- Industrial buildings
- Apartment blocks

Specification:

Colors: Bronze, Dark Bronze, Euro Grey, Mist Grey, Dark Grey, French Green, Dark Green, Ford Blue, Dark Blue, Pink, Golden, Silver, etc.

Thickness: 3mm, 4mm, 5mm, 5.5mm, 6mm, 8mm and 10mm, etc.

Sizes: 1524x2134mm, 1650x2140mm, 2140x3210mm, 2134x3300mm, 2250x3210mm, 2250x3300mm, etc.

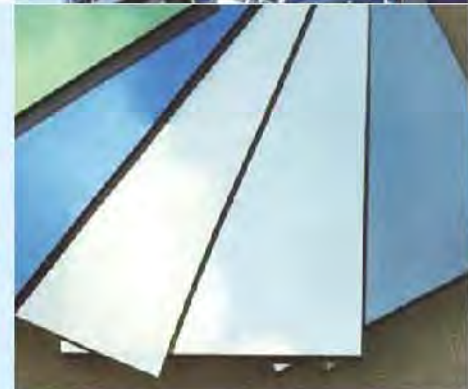
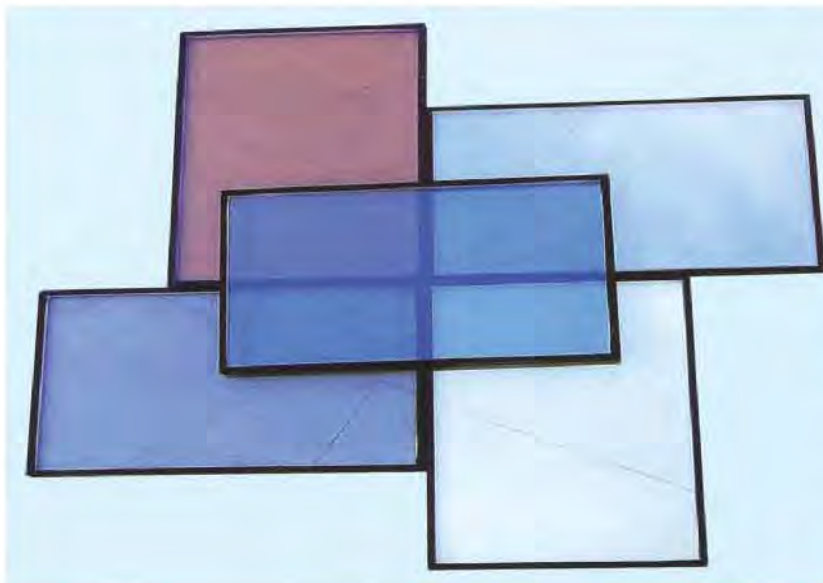

Low Emissivity Glass

Low Emissivity is a member of the coated glass family coated with one or more layers of metal or compound films on the quality float by using magnetic sputtering method. It has low thermal conductivity and high light transmittance, ensuring visible light transmittance and reducing light pollution based on prevention of heat losses.

Features:

- High efficiency in energy saving and environment protection
- Wonderful performance in visible light transmission
- Stable chemical performance
- Stable performance in thermal processing
- Stable mechanical performance for solid coat, high abrasion and scratch resistance

Application:

Low Emissivity Glass's primary application is wherever there is a need for enhanced thermal insulation and it achieves optimum performance from double glazing. It is widely used in facade glazing, windows double glazing, commercial buildings, gymnasiums and schools, etc.

Standard:

China GB/T 18915.1-2002, UK BS6206:1981; USA ANSIZ97.1; AUS AS/NIS 2208-1996

Specification:

Colors: Clear, Blue, Green, Bronze and Grey, etc.

Thickness: 4mm, 5mm, 6mm, 8mm and 10mm

Sizes: 1830x2440mm, 2134x3300mm, 2250x3300mm, 2440x3300mm, etc.

Coating Types: Online Hard Coating and Offline Soft Coating

Offline Low-E Glass Types: Single silver high transmittance,
Single silver high shading,
and Double silver, etc.



Laminated Glass

Laminated Glass is made by good quality adhesive interlayer and advanced bond technology. Laminated Glass is a kind of glass made of two or more sheets of top quality glass bonded together with a polyvinylbutyral (PVB) interlayer. After the PVB interlayer has been placed between the glass sheets, the whole assembly is subjected to heat and pressure. This makes the complete adhesion of the Vinyl and the glass. In the event of breakage, the glass fragments remain bonded to the plastic interlayer.

Features:

- Extremely high safety: The PVB interlayer withstands penetration from impact. Even if the glass cracks, splinters will adhere to the interlayer and not scatter. In comparison with other kinds of glass, laminated glass has much higher strength to resist shock, burglary, burst and bullets.
- Energy-saving building materials: PVB interlayer impedes the transmission of solar heat and reduces cooling loads.
- Create aesthetic sense to buildings: Laminated glass with a tinted interlayer will beautify the buildings and harmonize their appearances with surrounding views which meet the demand of architects.
- Sound control: PVB interlayer is an effective absorber of sound.
- Ultraviolet screening: The interlayer filters out ultraviolet rays and prevents the furniture and curtains from fading effect

Application:

- Sloped/Overhead Glazing
- Museums, Prisons, Government Buildings
- Jewelry Stores, Banks, Airports
- Safety Glazing Applications
- Schools, Hospitals, Hotels
- Interior Partition, Office Buildings

Specification:

PVB Colors: Clear, Green, Blue, Bronze, Grey, Milk White, etc.

Glass Colors: Clear, Extra Clear, French Green, Dark Green, Ford Blue, Dark Blue, Bronze, Euro Grey, etc. available with Reflective Glass also.

Thickness: 3+0.38+3mm, 4+0.38+4mm, 5+0.38+5mm, 6+0.38+6mm, 3+0.76+3mm, 4+0.76+4mm, 5+0.76+5mm, 6+0.76+6mm etc, could be produced as per request.

Sizes: 1830x2440mm, 2140x3300mm, 2250x3300mm, etc. max. 3300x15000mm, could be produced as per request.



Silver Mirror

Silver Coated Mirror is produced through a trinal processing work by coating a silver film, a copper film, and two layers of waterproof paints on the surface of glass. High quality clear float and modern mirror equipment combine to produce competitively priced mirrors of exceptionally high quality. This improved manufacturing process also improves the optical quality of the product and significantly increases its longevity through a better resistance to corrosion.

Features:

- High reflective, true image reflectance with virtually no distortion.
- High optical quality and durability.
- The mirror surface is clear and bright, giving distinct and life like image.
- The plating layer is rigid and bond and the protective layer impregnable with good erosion-resistance.
- Easy to be cut, drilled, or beveled, could be made into wall mirror, decorative mirror, safety mirror, furniture mirror, etc.

Application:

- Wardrobe door mirrors
- Bathroom mirrors
- Furniture applications
- Projection screens
- Display cases
- Decorative walls
- Ceiling and pillar covers
- Anytime you want a mirror offering sharp, beautiful reflectance and uncompromising durability

Specification:

Glass Colors: Clear, Ultra Clear, Bronze, Euro Grey, Dark Blue, Light Blue, Dark Green, Light Green, etc.

Back Paint Colors: Grey, Blue, Green, White, etc.

Thickness: 2mm, 3mm, 4mm, 5mm and 6mm etc.

Sizes: 1524x2134mm, 1220x1830mm, 1830x2440mm, 2134x3300mm, 2250x3210mm and 2250x3300mm etc.



Aluminum Mirror

High reflective Aluminum Mirror is produced through horizontal production line, which is the most advanced production equipment for coating aluminum mirror. High quality clear float and modern mirror equipment combine to produce competitively priced mirrors of exceptionally high quality. It is suitable for further processed and edge working. Our colored mirror is produced by vacuum coating a layer of aluminum on the tinted glass, which can supply you a different and nice decorating effect.

Features:

- Coated on the high quality float glass, exact image.
- Double coated Italian FENZI water-proof paint
- The plating layer is rigid and bonded. The protective layer is impregnable with good erosion-resistant.
- Actual and accurate reflection, high optical quality and durability.
- Easy to be cut, drilled, or beveled, could be made into wall mirror, decorative mirror, safety mirror, furniture mirror etc.

Application:

- For paneling mirror on walls or doors
- Furniture and shelves mirror
- Decorative mirror
- Dressing mirror

Specification:

Glass Colors: Clear, Ultra Clear, Bronze, Euro Grey, Dark Blue, Light Blue, Dark Green, Light Green, etc.

Back Paint Colors: Grey, Blue, Green, White, etc.

Paints: Single Coated, Double Coated

Thickness: 1.3mm, 1.8mm, 2mm, 3mm, 4mm, 5mm, 5.5mm and 6mm, etc.

Sizes: 1524x2134mm, 1220x1830mm, 1600x2200mm, 1830x2440mm, 2134x3300mm, 2250x3210mm and 2250x3300mm, etc.

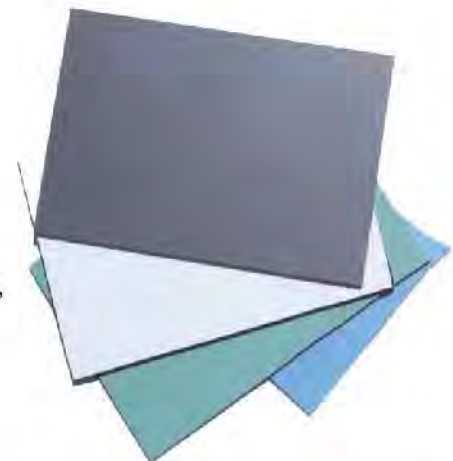

Doors

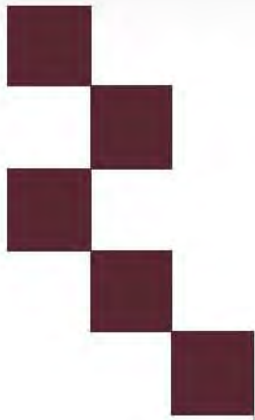

- Steel Door
- Steel & Aluminum Door
- Steel Glass Door
- Stainless Steel Door
- Luxury Copper Door
- Steel Wood Door
- Luxury PVC Wooden Door
- PVC Wooden Door
- American Steel Door
- HPL Door
- Melamine Door
- Bathroom Door
- Turkey Door



Steel Door

Material	Opening Size(mm)	Door Panel / Frame/Leaf Thickness/Frame Depth(mm)	Surface Finish (colour)	Opening Direction	Main Lock	
Cold -Rolled Steel	2050/2150* 750/860/900/960/ 1050/1100 or customized	-Door Panel: 0.3-1.2 -Door frame: 0.6-1.8 -Door leaf: 4,2,50,65,70,90 Frame Depth:49,80,90,100 120,145	-Powder Coating -Heat transfer printing -Metal Painting -Copper Painting -Etched Painting	-Left or Right -Inward or outward	<input checked="" type="checkbox"/> Double Movable <input type="checkbox"/> Quick Lock As page 17-18	
Second Lock	Hinge	Peephole & Doorbell	Doorsill	Gross Weight (kgs)	Package	
As page 18-19	Visible or Invisible: As page 19	As page 19	-Iron painted -Stainless steel No.430 -Stainless steel No.304 (Double deck)	17-85	Plastic film+Bubble bag/Foam+Carton +Packing belts	
Container Capacity(pcs/40'HQ)						
Size Item	2050*860*960*42	2050*860*960*50	2050*860*960*65	2050*860*960*70	2050*860*960*90	2050*1200*70
Frame Depth (mm)	49	80	90	100/125	145	100
Quantity (pcs/40'HQ)	600	400	360	270-300/230-250	210	230
Door Frame Architrave Design & Technical Drawing						
1-FA-80mm		2-FA-90mm		3-FA-105mm		
Remarks: Normal Punch:7-10mm Deep Punch:12-16mm Up Punch:22-25mm						

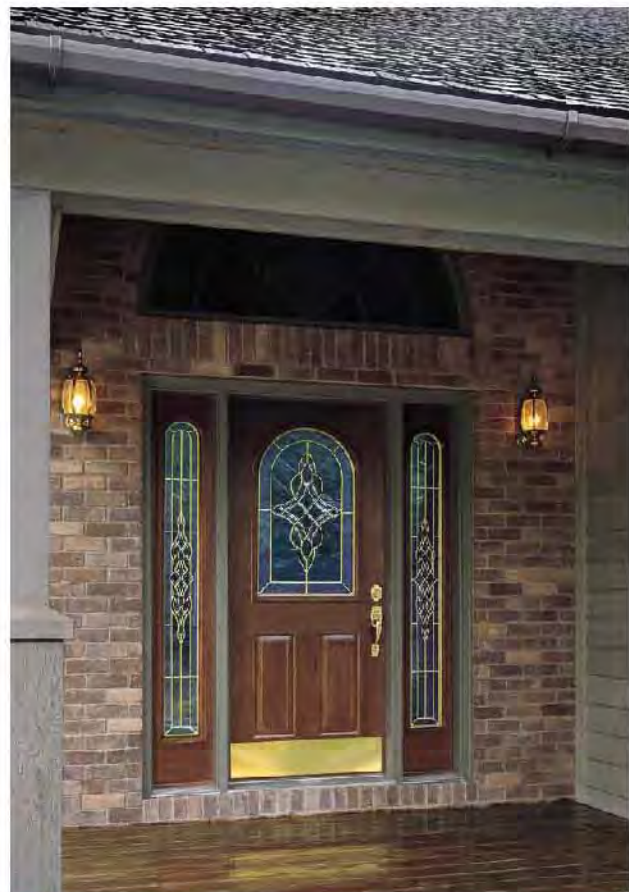
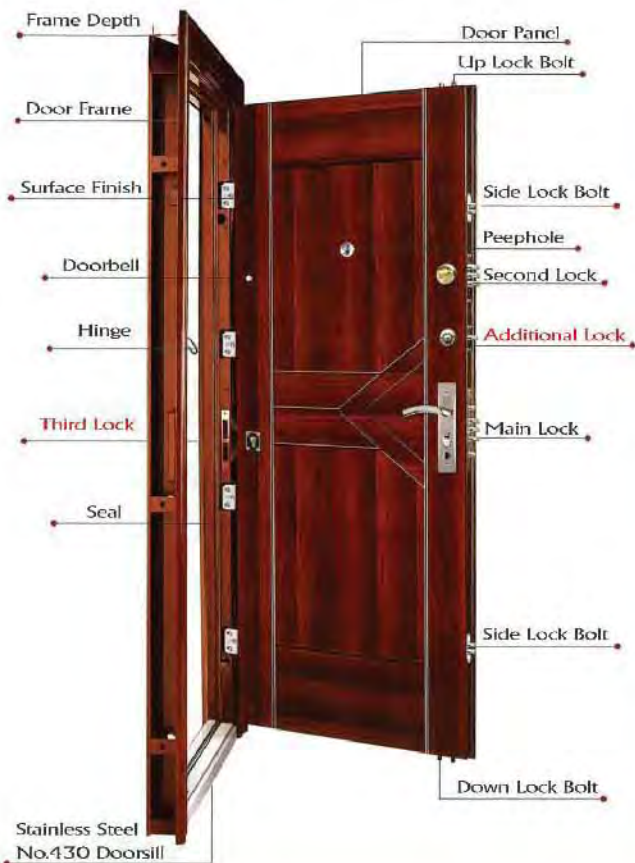

Doors

Steel Door



SD-SH01



SD-SH02



SD-SH03



SD-SH04



SD-SH05



SD-SH06



SD-SH07



SD-SH08



SD-SH09



SD-SH10



SD-SH11



SD-SH12



SD-SH13



SD-SH14



SD-SH15



SD-SH16



SD-SH17



SD-SH18



SD-SH19



SD-SH20
Black

Steel Door



SD-SH21
Copper Painting



SD-SH22



SD-SH23



SD-SH24



SD-SH25



SD-SH26



SD-SH27



SD-SH28



SD-SH29



SD-SH30



SD-SH31



SD-SH32



SD-SH33



SD-SH34



SD-SH35



SD-SH36



SD-SH37



SD-SH38



SD-SH39



SD-SH40

Doors

Steel Door



SD-SH41



SD-SH42



SD-SH43



SD-SH44



SD-SH45



SD-SH46



SD-SH47



SD-SH48



SD-SH49



SD-SH50



SD-SH51



SD-SH52



SD-SH53



SD-SH54



SD-SH55



SD-SH56



SD-SH57



SD-SH58



SD-SH59



SD-SH60

Steel Door



SD-SH61



SD-SH62



SD-SH63



SD-SH64



SD-SH65



SD-SH66



SD-SH67



SD-SH68



SD-SH69



SD-SH70



SD-SH71



SD-SH72



SD-SH73



SD-SH74



SD-SH75



SD-SH76



SD-SH77



SD-SH78



SD-SH79

Doors

Steel Door



SD-SH80



SD-SH81



SD-SH82



SD-SH83



SD-SH84



SD-SH85



SD-SH86



SD-SH87



SD-SH88

Steel & Aluminum Door



SAD-SH01
Wood Vein



SAD-SH02
Wood Vein



SAD-SH03
Black

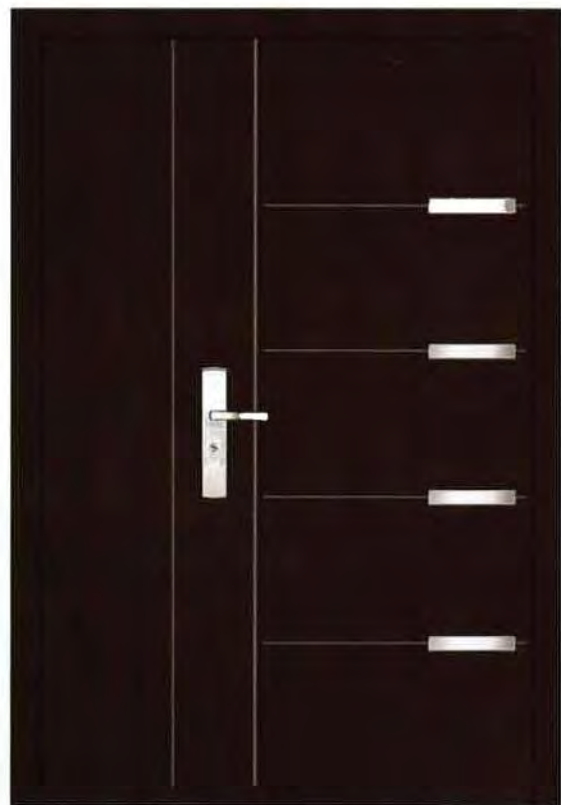

SAD-SH04
Black

Doors

Steel Glass Door



SGD-SH01



SGD-SH02



SGD-SH03



SGD-SH04



SGD-SH05



SGD-SH06



SGD-SH07



SGD-SH08



SGD-SH09



SGD-SH10



SGD-SH11



SGD-SH12

Steel Glass Door



SGD-SH12
Copper Painting



SGD-SH13
Etched Surface Finish



Steel Constructure For Glass



Door Frame Design



Etched & Copper Painting

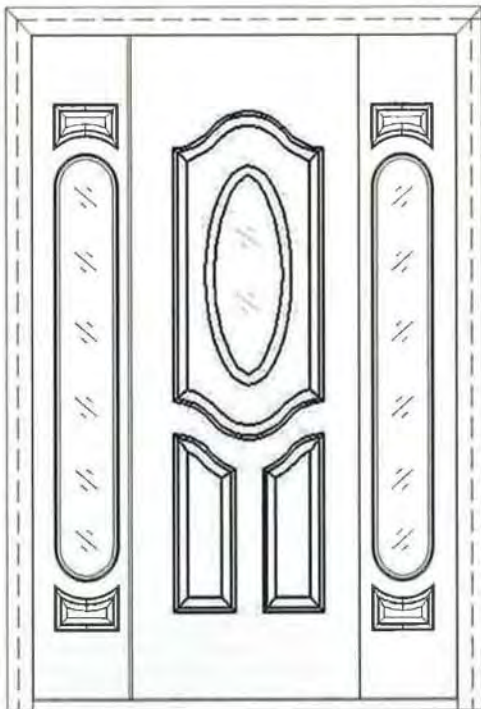

SGD-SH14

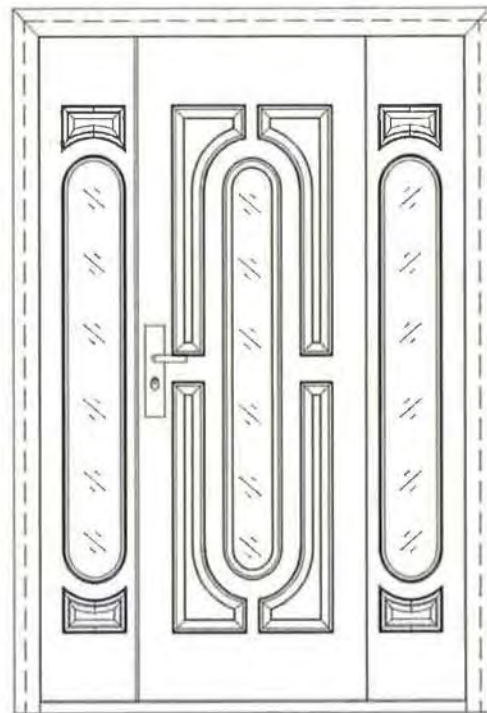

SGD-SH15

Doors

Steel Glass Door



Steel Constructure For Glass



Door Frame Design



Etched & Copper Painting



SGD-SH16



SGD-SH17



SGD-SH18



SGD-SH19

Steel Glass Door

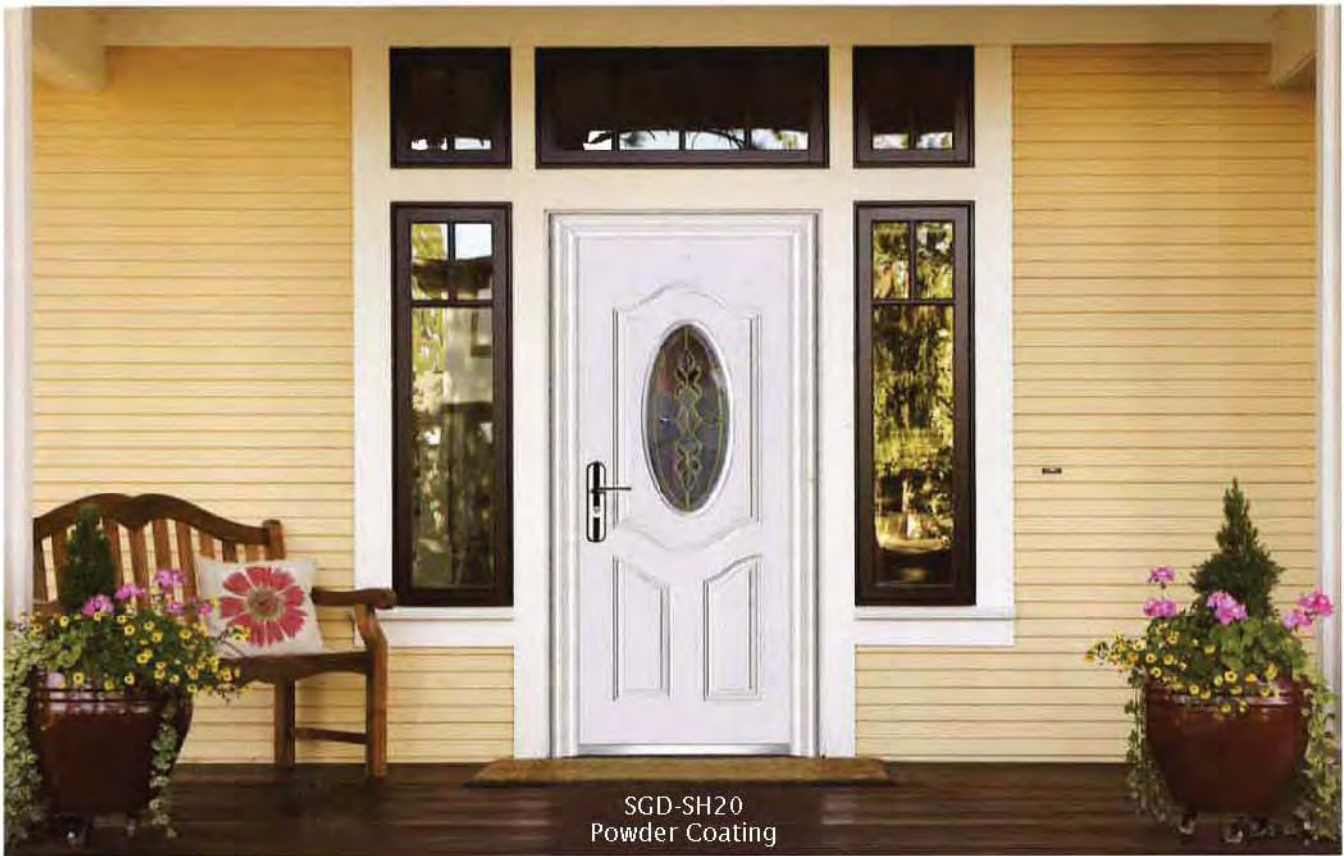

Doors

Steel Glass Door



SGD-SH22
Brown



SGD-SH23
Brown



SGD-SH24
Black

Stainless Steel Door

Material	Opening Size(mm)	Door Panel / Frame/Leaf Thickness/Frame Depth(mm)	Surface Finish (colour)	Opening Direction	Main Lock
SS 201# SS 304#	2050/2150* 860/960/1050/ 1200/1500 or customized	-Door Panel: 0.6-1.2 -Door frame: 1.0-2.0 -Door leaf: 70,90	-Sliver -Yellow Golden -Rose Golden -Black	-Left or Right -Inward or outward	<input checked="" type="checkbox"/> Double Movable <input type="checkbox"/> Quick Lock As page 17-18
Second Lock	Hinge	Glass	Doorsill	Gross Weight (kgs)	Package
As page 18-19	Visible or Invisible As page 19	Front: Tempered Glass Back: Grey Coated Glass	-Stainless steel 201# -Stainless steel 304#	45-85	Plastic film+Bubble bag/Foam+Carton +Packing belts
Container Capacity(pcs/40'HQ)					
Size Item	2050*860/960*70	2050*1200*70	2050*1500*70		
Frame Depth (mm)	100/125	100/125	100/125		
Quantity (pcs/40'HQ)	280	220	180		
Remarks: _____ _____ _____					



SSD-SH01



Doors

Stainless Steel Door



SSD-SH02



SSD-SH03



SSD-SH04



SSD-SH05



SSD-SH06



SSD-SH07



SSD-SH08



SSD-SH09



SSD-SH10

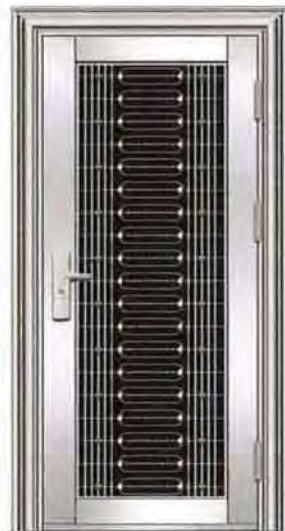

SSD-SH11



SSD-SH12



SSD-SH13

Stainless Steel Door

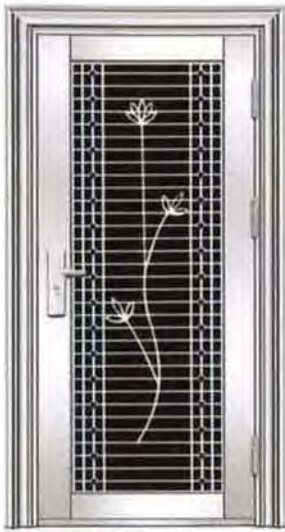

SSD-SH14



SSD-SH15



SSD-SH16



SSD-SH17



SSD-SH18



SSD-SH19



SSD-SH20



SSD-SH21



SSD-SH22



SSD-SH23



SSD-SH24



SSD-SH25

Doors

Stainless Steel Door



SSD-SH26



SSD-SH27



SSD-SH28



SSD-SH29

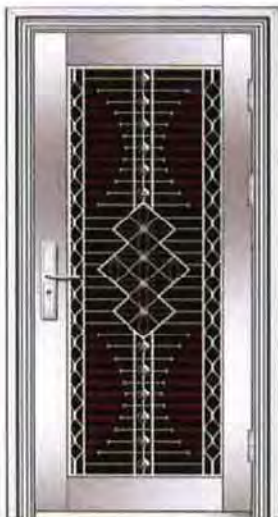

SSD-SH30



SSD-SH31



SSD-SH32



SSD-SH33



SSD-SH34

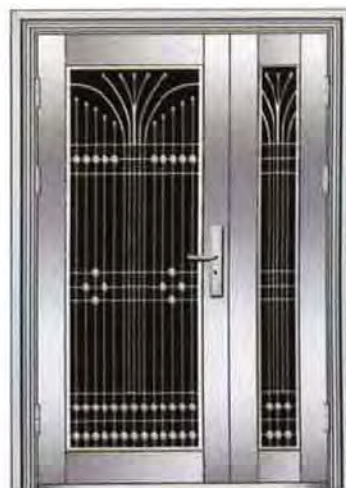

SSD-SH35



SSD-SH36



SSD-SH37

Stainless Steel Door



SSD-SH38



SSD-SH39



SSD-SH40



SSD-SH41



SSD-SH42



SSD-SH43



SSD-SH44



SSD-SH45

Doors

Stainless Steel Door



SSD-SH46



SSD-SH47



SSD-SH48



SSD-SH49



SSD-SH50



SSD-SH51



SSD-SH52



SSD-SH53

Stainless Steel Door

Door in Door



SSD-SH54



SSD-SH55

Twin Door



SSD-SH56



SSD-SH57



SSD-SH58

Sliding Door



SSD-SH59



SSD-SH60



SSD-SH61

Doors

Stainless Steel Door



SSD-SH62



SSD-SH63



SSD-SH64



SSD-SH65



SSD-SH66



SSD-SH67



SSD-SH68



SSD-SH69



SSD-SH70



SSD-SH71



SSD-SH72



SSD-SH73

Luxury Copper Door



LCD-SH01



LCD-SH02



LCD-SH03



LCD-SH04



LCD-SH05



LCD-SH06

Doors

Luxury Copper Door



LCD-SH07



LCD-SH08



LCD-SH09



LCD-SH10



LCD-SH11



LCD-SH12



LCD-SH13



LCD-SH14



LCD-SH15

Luxury Copper Door

Door Head



LCD-DH-SH01



LCD-DH-SH02



LCD-DH-SH03



LCD-DH-SH04



LCD-DH-SH05



LCD-DH-SH06

Door Frame



LCD-DF-SH01



LCD-DF-SH02



LCD-DF-SH03



LCD-DF-SH04



LCD-DF-SH05



LCD-DF-SH06



LCD-DF-SH07



LCD-DF-SH08



LCD-DF-SH09



LCD-DF-SH10



LCD-DF-SH11

Door Leaf Edge

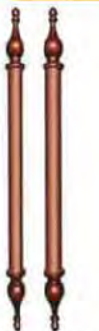

LCD-DLE-SH01



LCD-DLE-SH02



LCD-DLE-SH03



LCD-DLE-SH04



LCD-DLE-SH05



LCD-DLE-SH06



LCD-DLE-SH07



LCD-DLE-SH08



LCD-DLE-SH09

Doors

Steel Wood Door

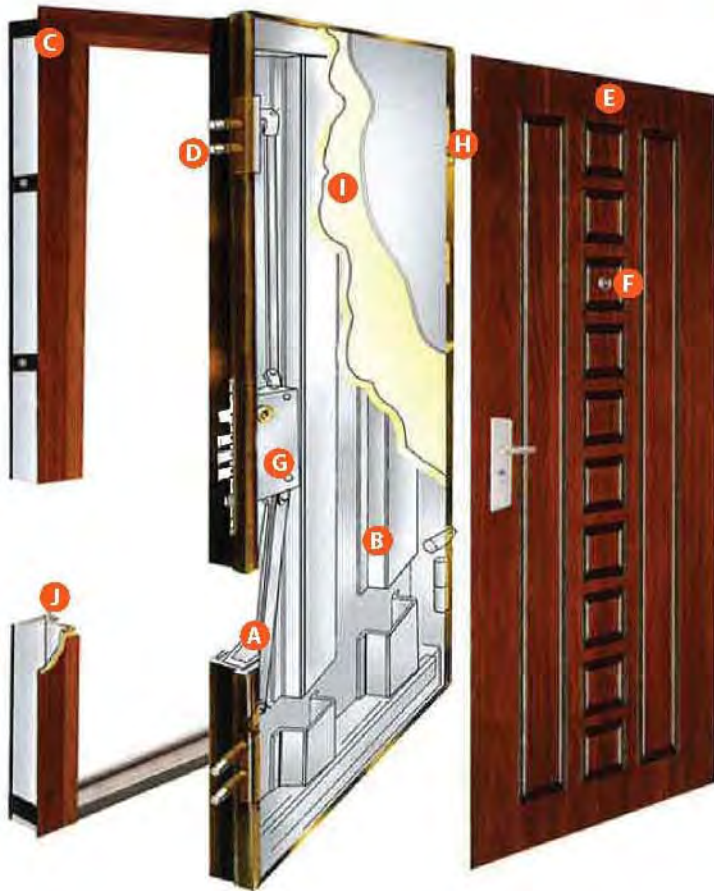

Specification

- A** Steel panel
- B** U type inner structure
- C** Decorative wood line
- D** Side lock bolts
- E** HDF + natural wood veneer + painting
- F** Peephole
- G** Lock box
- H** Hinge
- I** Honey-comb paper
- J** Rubble seal

Door Leaf Edge



Solid wooden door leaf edge



Stainless steel door leaf edge



Iron door leaf edge

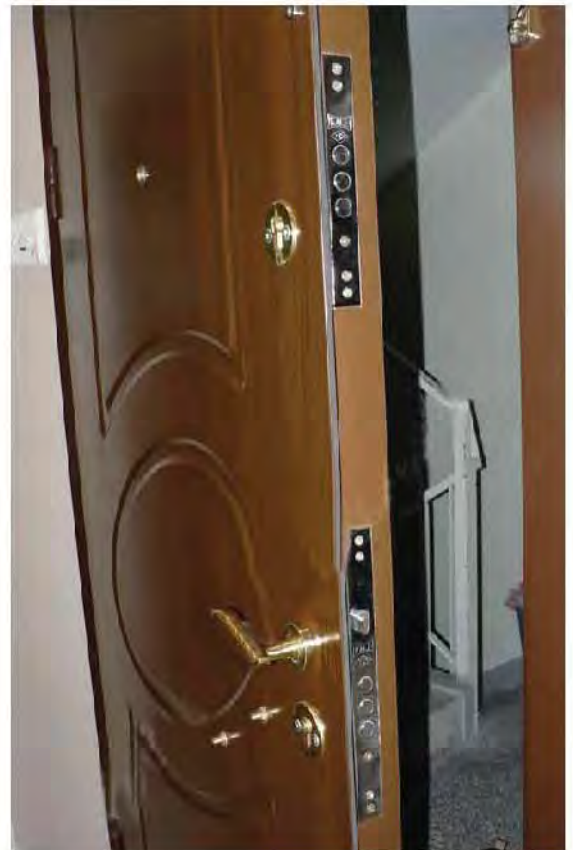

Steel Wood Door



SWD-SH01



SWD-SH02



SWD-SH03



SWD-SH04



SWD-SH05



SWD-SH06



SWD-SH07



SWD-SH08



SWD-SH09



SWD-SH10



SWD-SH11



SWD-SH12

Doors

Steel Wood Door



SWD-SH13



SWD-SH14



SWD-SH15



SWD-SH16



SWD-SH17



SWD-SH18



SWD-SH19



SWD-SH20



SWD-SH21



SWD-SH22



SWD-SH23



SWD-SH24

Steel Wood Door



SWD-SH25



SWD-SH26



SWD-SH27



SWD-SH28

Doors

Luxury PVC Wooden Door



LPVC-SH01



LPVC-SH04



LPVC-SH05



LPVC-SH02



LPVC-SH06



LPVC-SH07



LPVC-SH03



LPVC-SH08



LPVC-SH09

Luxury PVC Wooden Door



LPVC-SH10



LPVC-SH11



LPVC-SH12



LPVC-SH13



LPVC-SH14



LPVC-SH15



LPVC-SH16



LPVC-SH17

Doors

PVC Wooden Door

Material	HDF Coated With PVC Film	
	HDF Thickness	<input checked="" type="checkbox"/> 5mm <input type="checkbox"/> 6mm <input type="checkbox"/> 8mm <input type="checkbox"/> Customized
	PVC Film Thickness	<input checked="" type="checkbox"/> 0.14mm <input type="checkbox"/> 0.16mm <input type="checkbox"/> 0.18mm <input type="checkbox"/> Customized
	Filling Material	<input checked="" type="checkbox"/> Finger Wood Strip(4pcs) <input type="checkbox"/> Solid Fir Wood <input type="checkbox"/> Honeycomb Paper
Size	Door Leaf Size	<input checked="" type="checkbox"/> 2000x800x40mm (standard) <input type="checkbox"/> Customized
	Door Frame Thickness	<input checked="" type="checkbox"/> 23mm(Economy) <input type="checkbox"/> 35mm <input type="checkbox"/> 40mm <input type="checkbox"/> Customized
	Door Frame Width (Wall Thickness)	<input checked="" type="checkbox"/> 100mm (Standard) <input type="checkbox"/> 150mm <input type="checkbox"/> 290mm <input type="checkbox"/> Customized
Door Frame	Frame Design	<input checked="" type="checkbox"/> B,Adjustable Frame <input type="checkbox"/> H,Italy Frame <input type="checkbox"/> I,Romania Frame
	Frame Material	<input type="checkbox"/> A, 100% Pure MDF+PVC <input checked="" type="checkbox"/> B,MDF+Plywood+MDF+PVC Film <input type="checkbox"/> C/D,MDF+Finger Wood+MDF+PVC <input type="checkbox"/> F,100% Pure Solid wood <input type="checkbox"/> J,WPC
Architrave	Architrave Material	<input checked="" type="checkbox"/> MDF <input type="checkbox"/> 100% Pure Solid wood <input type="checkbox"/> WP(Wood Plastic) <input type="checkbox"/> WPC
	Architrave Line Width	<input checked="" type="checkbox"/> 60mm (Standard) <input type="checkbox"/> 80mm <input type="checkbox"/> 100mm <input type="checkbox"/> Customized
	Architrave Line Thickness	<input checked="" type="checkbox"/> 12mm (Standard) <input type="checkbox"/> 10mm <input type="checkbox"/> 18mm <input type="checkbox"/> 15mm <input type="checkbox"/> Customized
Accessories	Lock Set (Lock Handle, Lock body, Lock Cylinder) ,Hinge,Glass	
Packing	Plastic Film + Carton,Door Leaf & Door Frame Separately Packing	
Container Capacity	220pcs/20'FCL 450pcs/40'HQ	
Remarks:		
<u>Door Leaf Weight: 18-23 /28-32(kg)</u>		
<u>Door Frame Weight: 17-23(kg)</u>		



PVC Wooden Door



PVCW-SH01



PVCW-SH02



PVCW-SH03



PVCW-SH04



PVCW-SH05



PVCW-SH06



PVCW-SH07



PVCW-SH08



PVCW-SH09



PVCW-SH10



PVCW-SH11



PVCW-SH12



PVCW-SH13



PVCW-SH14



PVCW-SH15



PVCW-SH16



PVCW-SH17



PVCW-SH18



PVCW-SH19



PVCW-SH20

Doors

PVC Wooden Door



PVCW-SH21



PVCW-SH22



PVCW-SH23



PVCW-SH24



PVCW-SH25



PVCW-SH26



PVCW-SH27



PVCW-SH28



PVCW-SH29



PVCW-SH30

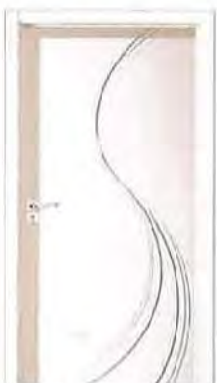

PVCW-SH31



PVCW-SH32



PVCW-SH33



PVCW-SH34



PVCW-SH35



PVCW-SH36



PVCW-SH37



PVCW-SH38



PVCW-SH39



PVCW-SH40

PVC Wooden Door



PVCW-SH41



PVCW-SH42



PVCW-SH43



PVCW-SH44



PVCW-SH45



PVCW-SH46



PVCW-SH47



PVCW-SH48



PVCW-SH49



PVCW-SH50



PVCW-SH51



PVCW-SH52



PVCW-SH53



PVCW-SH54



PVCW-SH55



PVCW-SH56



PVCW-SH57



PVCW-SH58



PVCW-SH59



PVCW-SH60

Doors

PVC Wooden Door



PVCW-SH61



PVCW-SH62



PVCW-SH63



PVCW-SH64



PVCW-SH65



PVCW-SH66



PVCW-SH67



PVCW-SH68



PVCW-SH69



PVCW-SH70



PVCW-SH71



PVCW-SH72



PVCW-SH73



PVCW-SH74



PVCW-SH75



PVCW-SH76



PVCW-SH77



PVCW-SH78



PVCW-SH79



PVCW-SH80

American Steel Door

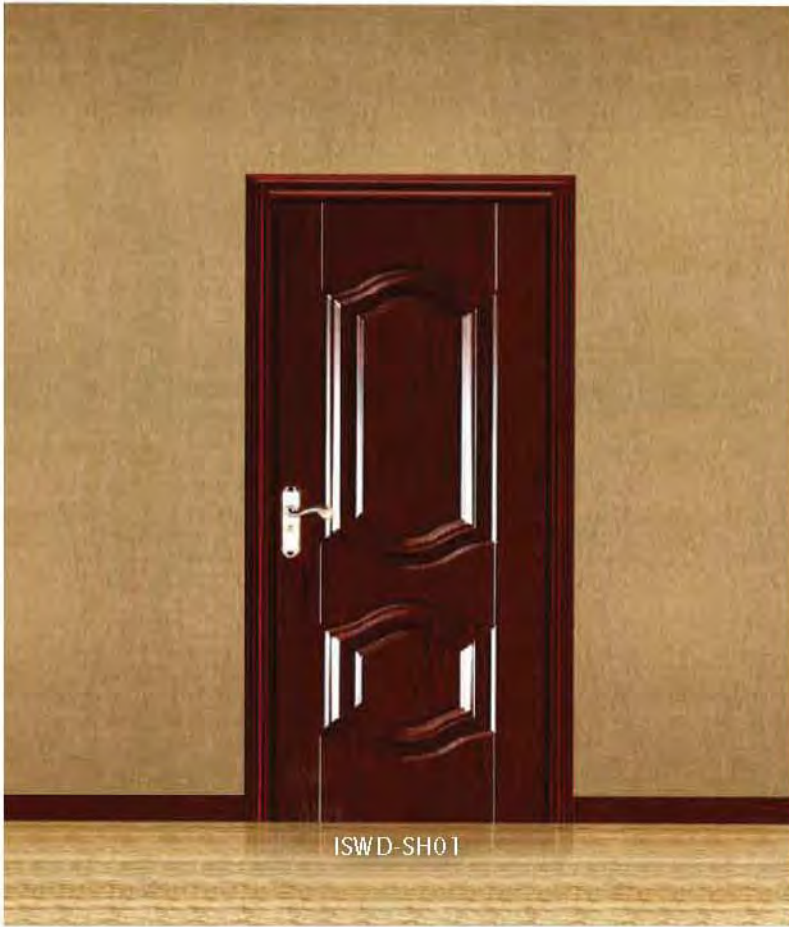

ISWD-SH01



ISWD-SH02



ISWD-SH03



ISWD-SH04



ISWD-SH05



ISWD-SH06



ISWD-SH07



ISWD-SH08



ISWD-SH09



ISWD-SH10

Door Frame & Architrave



F-SH01
(Plywood + WP)



F-SH02
(Solid Wood)



F-SH03
(Steel)

Door Leaf Edge



E-SH01
(Solid Wood + WP)

Doors

HPL Door



HPLD-SH01



HPLD-SH02



HPLD-SH03



HPLD-SH04



HPLD-SH05



HPLD-SH06



HPLD-SH07



HPLD-SH08



HPLD-SH09



HPLD-SH10

SPECIFICATION

- 1- Size: 2100*800*40 or Customized;
- 2- Surface Material: 0.7mm HPL;
- 3- Door Leaf Edge: ABS Edge;
- 4- Filling Material: 4 PCS of MDF Strips/Chipboard/Perlite board;
- 5- Frame: As Photos;
- 6- Architrave: A-01(PVC Wooden) A-10(WP);
- 7- Function: Waterproof, Soundproof, Fireproof, Etc.,

PHOTOS



1

4pcs MDF Strips Core



2

Chipboard Core



3

Solid Wooden Core



4

0.7mm HPL+4mm Plywood +12mm Fir Wood +0.7mm HPL;

Material Information

1. Door Frame Specification (Code/Design/Material)

Code	Door Frame Design & Photo	Material Type & Thickness Specification	Door Series
A	 Adjustable Frame	<ul style="list-style-type: none"> ■ 100% Pure MDF ■ $8+7+8=23 \times (15 \times 13) \times (6+8/12) \times 60/80\text{mm}$ 	PVC Wooden Door
B	 Adjustable Frame	<ul style="list-style-type: none"> ■ MDF+Plywood+MDF ■ $8+7+8=23 \times (15 \times 13) \times (6+8/12) \times 60/80\text{mm}$ 	PVC Wooden Door
C	 Adjustable Frame	<ul style="list-style-type: none"> ■ MDF+Finger Wood+MDF ■ $5+12+5=22 \times (15 \times 13) \times (6-8/12) \times 60/80\text{mm}$ 	PVC Wooden Door
D	 Adjustable Frame	<ul style="list-style-type: none"> ■ MDF+Finger Wood+MDF ■ $6+23+6=35 \times (6+12/15) \times 60/80/100\text{mm}$ ■ $6+27+6=39 \times (6+12/15) \times 60/80/100\text{mm}$ 	<ul style="list-style-type: none"> ■ PVC Wooden Door ■ Veneer Painting Door
E	 Adjustable Frame	<ul style="list-style-type: none"> ■ MDF+Finger Wood+MDF ■ $6+12+6=24 \times 12 \times (6+12/15) \times 60/80/100\text{mm}$ 	Veneer Painting Door
F	 Adjustable Frame	<ul style="list-style-type: none"> ■ 100% Pure Solid Wood ■ Red Walnut □ Customized ■ $35 \times (30+60/70) \times 10/12/15/18\text{mm}$ □ $40 \times (30+60/70) \times 10/12/15/18\text{mm}$ 	Veneer Painting Door
G	 Adjustable Italy Frame	<ul style="list-style-type: none"> ■ 100% Pure MDF ■ $12+5+15+5=37 \times (6+15) \times 70/100$ ■ $12+6+15+6=39 \times (6+15) \times 70/100$ 	PVC Wooden Door
H	 Adjustable Italy Frame	<ul style="list-style-type: none"> ■ MDF+Finger Wood+MDF ■ $12+5+15+5=37 \times (6+15) \times 70/100$ ■ $12+8+12+8=40 \times (6+15) \times 70/100$ 	PVC Wooden Door
I	 Romania Frame	<ul style="list-style-type: none"> ■ MDF+Finger Wood+MDF ■ $12+5+15+5=37 \times 8 \times 60\text{mm}$ 	PVC Wooden Door
J	 Wood Plastic Frame	<p>Door Jamb Size(H&W):</p> <ul style="list-style-type: none"> ■ $2150 \times 100\text{mm}$ □ $2150 \times 120/140/160/180/200/220/240/260\text{mm}$ ■ Architrave: $60 \times 40/42/45\text{mm}$ ■ Door casing can be adjusted 40mm 	<ul style="list-style-type: none"> □ PVC Wooden Door □ Veneer Painting Door ■ Melamine Door ■ ABS Door

Material Information

2. Architrave Design & Size

2.1 MDF



A-SH01

2200x(30+60/80)x6/8mm



A-SH02

2200x(30+70/100)x15mm



A-SH03

2200x80x15mm



A-SH04

2200x80x12mm



A-SH05

2200x60x8mm

2.2 Pure Solid Wood



A-SH06

2200x(30+60)x15mm



A-SH07

2200x(30+60)x15mm



A-SH08

2200x(30+70)x15mm



A-SH09

2200x(30+70)x18mm

2.3 WP(Wood Plastic)



A-SH10

2200x(25+60)x9mm



A-SH11

2200x(25+70)x10mm



A-SH12

2200x(24+75)x10mm



A-SH13

2200x(20+86)x28mm



A-SH14

2200x80x12mm

3. Door Frame Corner Style

1-45 Degree Corner



1-45 Degree Corner



Material Information

4. Door Leaf Edge



1-
Wooden
Material Edge



2-
ABS (Plastic)
Material Edge

5. Inner Filling



1-4pcs MDF Strips Core



2-Honycomb Core



3-Chipboard Core



4-Particle Board Core



5-Solid Wood Core



6-Fire Rated Core

6. Glass



G-SH01
(Diamond)



G-SH02
(Frozen)



G-SH03
(Mixed Grid)



G-SH04
(Iced)



G-SH05
(Meteor Shower)



G-SH06
(Brown)



G-SH07
(Sunset)



G-SH08
(Feather)

Doors

Material Information

7. Lockset

7.1 Lock Handle



Material Information

7.2 Lock Body



LB-SH50
(Silver Square)



LB-SH50
(Silver Round)



LB-SH58S
(Silver)



LB-SH58G
(Golden)



LB-SH85
(Silver, Golden)

7.3 Lock Cylinder



LC-SH01



LC-SH02



LC-SH03



LC-SH04-No Key
(For Bathroom)

8. Hinge

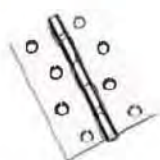

H-SH01



H-SH02



H-SH03



H-SH04



B-SH01

9. Aluminum Decoration Line



SH01 (7.0mm Width)



SH02 (10mm Width)



SH03 (7.0mm Width)



SH04 (7.0mm Width)
Plastic

Material Information

11. Color

P.S.: The exact colour should be accordingly with the real sample

11.1 Smooth Feeling



White Oak-SH01



Light Oak-SH02



Red Oak-SH03



Thai Teak-SH04



Black Walnut-SH05



Walnut Wood-SH06



Red Cherry-SH07



Iron Peach Wood-SH08



White Ash-SH09



Light Maple Wood-SH10



Red Wood-SH11



Mahogany-SH12

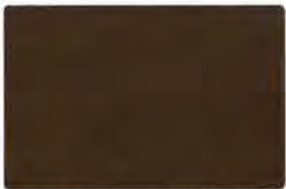

Wenge-SH13



Gold Cedar-SH14



Sapele-SH15



Pear Wood-SH16

11.2 Texture Feeling



European Oak



Burma's Oak



Red Spelling Wood
(light)



South Africa Mai Geli



Gold Red Grapefruit



The French Pine



American Walnut



Gold-rimmed
Black Pomelo

Melamine Door

Material	HDF Coated With Melamine Painting Sheet	
	HDF Thickness	<input type="checkbox"/> 3.0mm <input checked="" type="checkbox"/> 4.5mm <input type="checkbox"/> Customized
	Density Thickness	<input checked="" type="checkbox"/> 920kgs/m ³
	Filling Material	<input checked="" type="checkbox"/> Finger Wood Strip(4pcs) <input type="checkbox"/> Honeycomb Paper
Size	Door Leaf Size	<input checked="" type="checkbox"/> 2000x800x40mm (standard) <input type="checkbox"/> Customized
	Door Frame Width (Wall Thickness)	<input checked="" type="checkbox"/> 100mm (Standard) <input type="checkbox"/> 150mm <input type="checkbox"/> 290mm <input type="checkbox"/> Customized
	Decoration Line Width	<input checked="" type="checkbox"/> 60mm (Standard) <input type="checkbox"/> 80mm <input type="checkbox"/> Customized
Door Frame	Frame Design	<input checked="" type="checkbox"/> Adjustable Frame <input type="checkbox"/> Italy Frame <input type="checkbox"/> Romania Frame
	Frame Material	<input type="checkbox"/> A,00% Pure MDF <input checked="" type="checkbox"/> B,MDF+Plywood+MDF+Melamine Film <input type="checkbox"/> C/D,MDF+Finger Wood+MDF <input type="checkbox"/> F,100% Pure Solid wood
Architrave	Architrave Material	<input type="checkbox"/> MDF <input type="checkbox"/> 100% Pure Solid wood <input checked="" type="checkbox"/> PW(Plastic Wood)
	Architrave Line Width	<input checked="" type="checkbox"/> 60mm (Standard) <input type="checkbox"/> 80mm <input type="checkbox"/> 100mm <input type="checkbox"/> Customized
	Architrave Line Thickness	<input checked="" type="checkbox"/> 8mm (Standard) <input type="checkbox"/> 10mm <input type="checkbox"/> 12mm <input type="checkbox"/> 15mm <input type="checkbox"/> Customized
Accessories	Lock Set (Lock Handle, Lock Body, Lock Cylinder) Hinge,Glass,	
Door Set Packing & Container Capacity	Plastic Film + Carton,Door Leaf & Door Frame Separately Packing	
	220pcs/20'FCL 450pcs/40'HO	
Remarks:	_____	

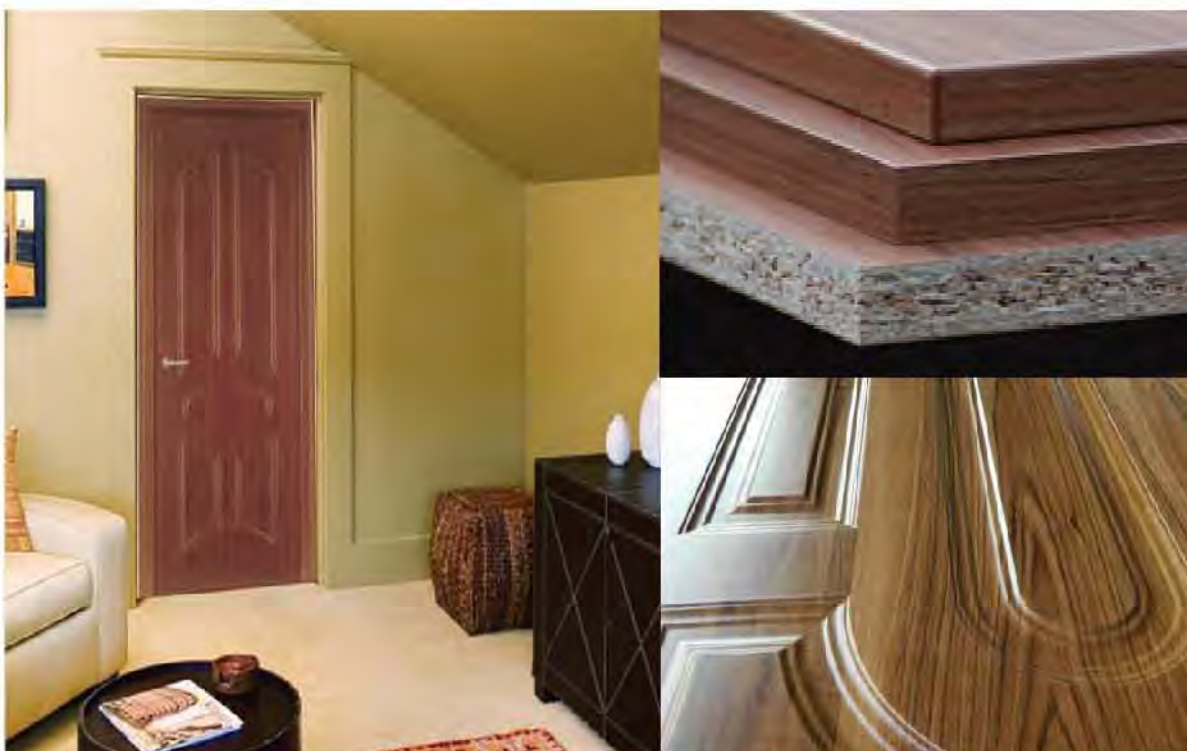

Doors

Melamine Door



Bathroom Door

UPVC Door



Doors

Bathroom Door

Aluminum Alloy Door



BD-SH19



BD-SH20



BD-SH21



BD-SH22



BD-SH23



BD-SH24



BD-SH25



BD-SH26



BD-SH27



BD-SH28



BD-SH29



BD-SH30



BD-SH31



BD-SH32



BD-SH33



BD-SH34

Turkey Door

Laminox Eco Panel Door



Laminox Eco Panel Door With Chrome



Doors

Turkey Door

Laminox Eco Panel Door



(A)Rustic (B)Black Walnut



(A)Rustic (B)Black Walnut



(A)Rustic (B)Black Walnut



(A)Rustic (B)Black Walnut



(A)Rustic (B)Black Walnut



(A)Rustic (B)Black Walnut

Turkey Door

Laminox Eco Panel Door



TD-SH24



TD-SH25



TD-SH26



TD-SH27



TD-SH28



TD-SH29



TD-SH30



TD-SH31



TD-SH32

Classic Door



TD-SH33



TD-SH34

Doors

Turkey Door

Classic Door



TD-SH35



TD-SH36



TD-SH37



TD-SH38



TD-SH39



TD-SH40



TD-SH41



TD-SH42



TD-SH43

Turkey Door

Classic Door



TD-SH44



TD-SH45



TD-SH46



TD-SH47



TD-SH48



TD-SH49



TD-SH50



TD-SH51



TD-SH52



TD-SH53



TD-SH54



TD-SH55



TD-SH56



TD-SH57



TD-SH58



TD-SH59



TD-SH60



TD-SH61



TD-SH62



TD-SH63

Doors

Turkey Door

Classic Door



TD-SH64



TD-SH65



TD-SH66



TD-SH67



TD-SH68



TD-SH69



TD-SH70



TD-SH71



TD-SH72



TD-SH73



TD-SH74



TD-SH75



TD-SH76



TD-SH77



TD-SH78



TD-SH79



TD-SH80



TD-SH81



TD-SH82



TD-SH83

Turkey Door

Classic Door



TD-SH84



TD-SH86



TD-SH87



TD-SH88



TD-SH89



TD-SH90



TD-SH91



TD-SH92



TD-SH93



TD-SH94



TD-SH85



TD-SH95



TD-SH96

Roofing

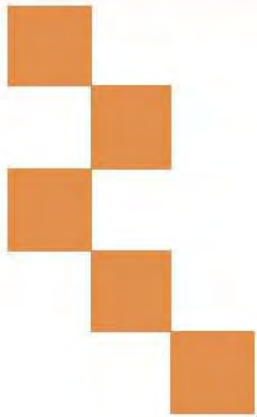

- Classical Tile
- Modern Classical Tile
- Shingle Tile
- Rainbow Tile
- Makuti Grained Tile

Stone Coated Steel Roofing Tile

Classical Tile

Model No.	SH01	SH02
Tile Size	1400mmx420mm	1340mmx420mm
Installed Exposure	1340mmx370mm	1290mmx370mm
Tiles per Square Meter	2 Sheets	2.08 Sheets
Installed Weight	3.0kg/Sheet	2.8kg/Sheet



Modern Classical Tile

Model No.	SH03
Tile Size	1340mmx420mm
Installed Exposure	1290mmx370mm
Tiles per Square Meter	2.08 Sheets
Installed Weight	2.8kg/Sheet



Shingle Tile

Model No.	SH04
Tile Size	1340mmx420mm
Installed Exposure	1290mmx370mm
Tiles per Square Meter	2.08 Sheets
Installed Weight	2.8kg/Sheet



Rainbow Tile

Model No.	SH05
Tile Size	1300mmx420mm
Installed Exposure	1250mmx370mm
Tiles per Square Meter	2.16 Sheets
Installed Weight	2.8kg/Sheet



Makuti Grained Tile

Model No.	SH06
Tile Size	1340mmx420mm
Installed Exposure	1290mmx370mm
Tiles per Square Meter	2.08 Sheets
Installed Weight	2.8kg/Sheet



Roofing

Color Chart

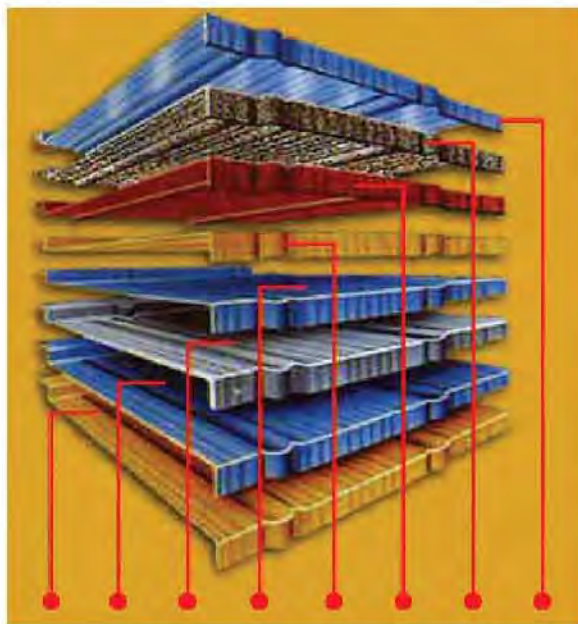

Clear acrylic overglaze
 Natural stone chips
 Basecoat
 Acrylic resin protective coat
 Zinc-aluminium
 Steel base
 Zinc-aluminium
 Acrylic resin protective coat



SH101

Terracotta



SH102

Beige Red



SH103

Khaki



SH104

Sky Blue



SH105

Smoky Gray



SH106

Wine Red



SH107

Coffee Brown



SH108

Forest Green



SH109

Coffee Black



SH110

Black & White



SH111

Brown Black



SH112

Black Red



SH113

Green Black



SH114

Arctic Blue



SH115

Black

Main Accessories

Angle Ridge Cap



Angle Ridge Cap II

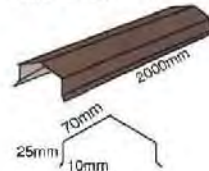

Square Ridge Cap



Wall Side Flashing



Valley Tray

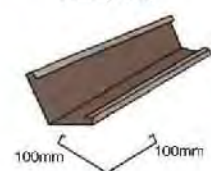

Circular Ridge Cap

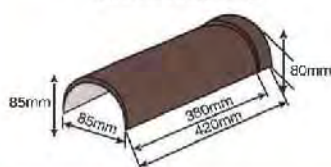

Barge Board Cover

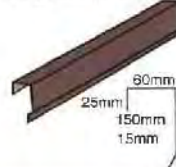

Flat Board



Facial Board



Stone Coated Steel Roofing Tile

Makuti Grained Tile



Rainbow Tile



Modern Classical Tile



Classical Tile



Shingle Tile



Roofing

Piping

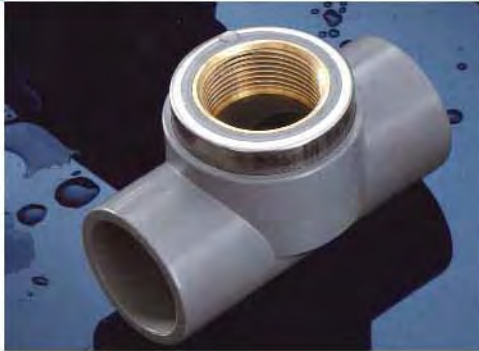
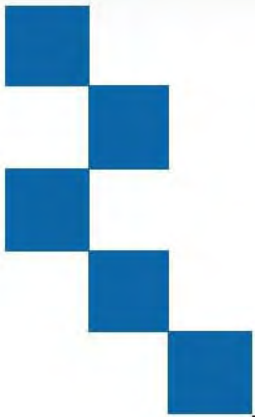

■ PVC Rainwater Gutter & Fitting

PVC Raineater Gutter & Fitting

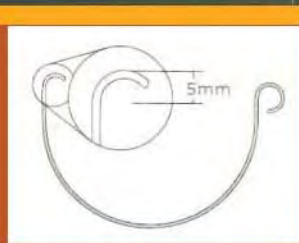
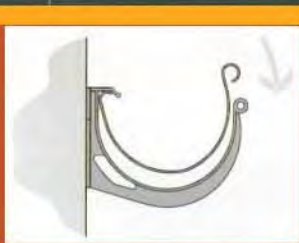
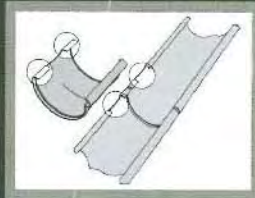
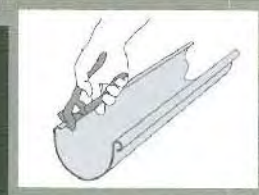
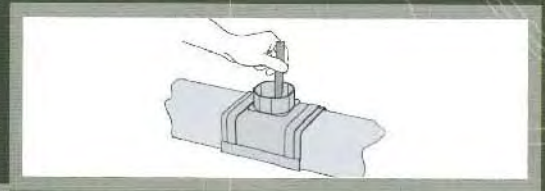
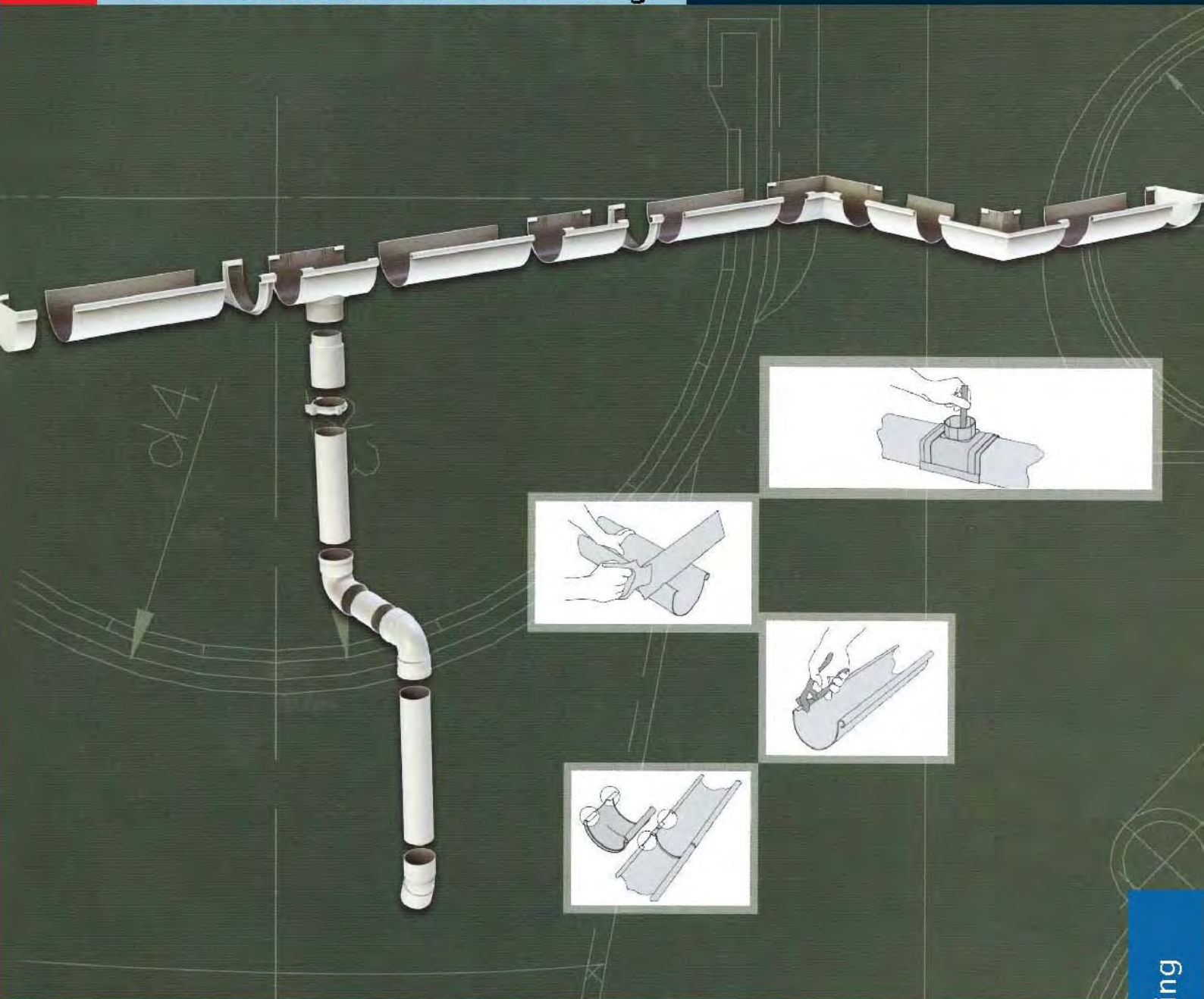

PVC RAINWATER GUTTER & FITTING

Piping

PVC Rainwater Gutter & Fitting

PVC Gutter System Characteristic

1. Double-wall internal structure designed to keep the lasting strength and stiffness.
2. High temperature resistant PVC material, can withstand long time of sunlight exposure.
3. Easy installation, no need of special tools.
4. The whole gutter system, beautiful shape, elegant colour and lustre.

Installation Points

- **First Step:** Draw horizontal mounting lines, stainless crews hanging the gutter connector.
- **Second Step:** Install gutters, use the rivet and lap way connect the gutter and gutter(lap joints need special glue)
- **Third Step:** Pre-install downspouts, confirm the location of the drain, install the accessory that connect the gutter and downspout(gutter outlet)
- **Fourth Step:** Install downspouts, confirm the location of the downspout bracket, the space between the downspout brackets, is not more than 1.2m, use the stainless screw to hang the downspout bracket.

Node Treatment of PVC Gutter System

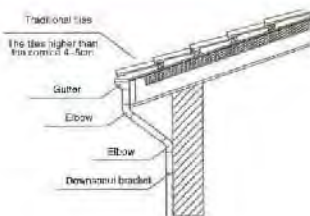

The node of traditional eaves

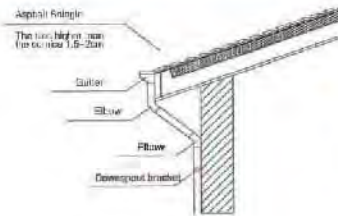

The node of asphalt Shingle



The node of air condition drain

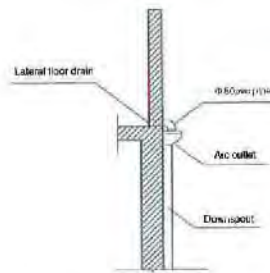

The node of terrace drain

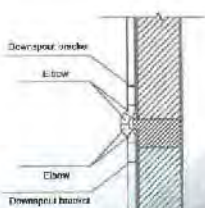

Wallline treatment

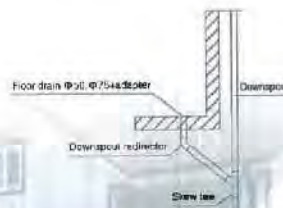

The node of Balcony drain



PVC Rainwater Gutter & Fitting

5 Inch PVC Gutter System

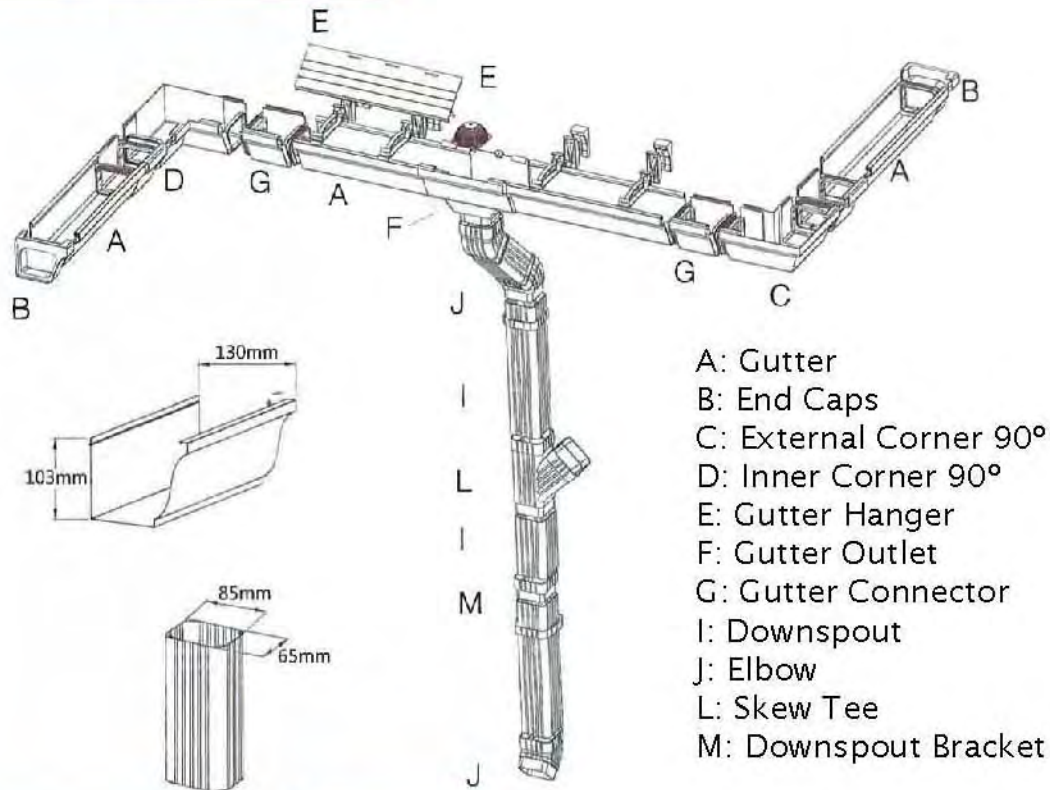

Product



Piping

PVC Rainwater Gutter & Fitting



110mm Rainwater System Components

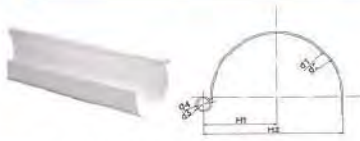

Item No.: RWG-SH001

RAIN GUTTER

Nom Size	d1	d2	d3	d4	H1	H2
110	118.5	121.3		11.9	66.5	127.2



Item No.: RWG-SH002

TEE

Nom Size	d1	d2	d3	d4	H	L
110	75.7	79.5	115.3	119.5	201.3	47



Item No.: RWG-SH003

COUPLING

Nom Size	d1	d2	H
110	117.1	121.5	140.2



Item No.: RWG-SH004a

ANGLE CONNECTOR LEFT

Nom Size	H	L	D
110	176	29.8	116.2

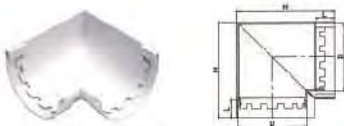

Item No.: RWG-SH004b

ANGLE CONNECTOR RIGHT

Nom Size	H	L	D
110	163.5	29.8	116.2



Item No.: RWG-SH005

CLAMP

Nom Size	D	H
110	121	145.6



Item No.: RWG-SH006

END CAP LEFT

Nom Size	d1	d2	H
110	117.1	121.5	140.2



Item No.: RWG-SH007

END CAP RIGHT

Nom Size	d1	d2	H
110	117.1	121.5	140.2



Item No.: RWG-SH008

UDE01 90° ELBOW

Nom Size	d	D	L
110	80.5	88.5	45



Item No.: RWG-SH009

UDE03 45° ELBOW

Nom Size	d	D	L
110	80.5	84.5	46.7



Item No.: RWG-SH010

METAL CLAMP

Nom Size	d	D	L
110			



Item No.: RWG-SH011

CLIP

Nom Size	L	L1	D
80	93.9	58	80



PVC Rainwater Gutter & Fitting

110mm Rainwater System Components

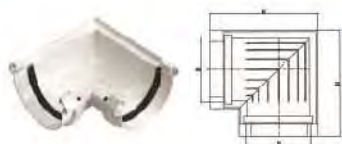

Item No.: RWG-SH004c

■ ANGLE CONNECTOR WITH GASKET

Nom Size	D	H
110	120.67	199.45



Item No.: RWG-SH003a

■ COUPLING WITH GASKET

Nom Size	D	H	A
110	116.2	152.3	100



Item No.: RWG-SH002a

■ TEE WITH GASKET

Nom Size	A	H	L	d1	d2	d3	d4
110	152.3	191.2	43	74.4	84.5	116.2	121.2

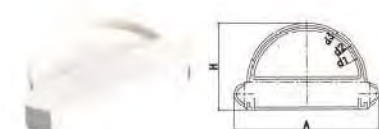

Item No.: RWG-SH005a

■ END CAP TYPE II

Nom Size	H	A	d1	d2	d3
110	88.5	146.4	112	116.2	121.2



Item No.: RWG-SH010

■ COUPLING M/F

Nom Size	D	d	d1	L	H
80	86.5	80	74.7	85.3	137.5

125mm Rainwater System Components



Item No.: RWGS-SH001

■ RAIN GUTTER

Nom Size	d1	d2	d3	d4	H1	H2
125	125	128.4	14.7	11.1	70	134.2



Item No.: RWGS-SH003

■ COUPLING

Nom Size	D	H	A
125	131	210	169



Item No.: RWGS-SH004

■ ANGLE CONNECTOR

Nom Size	H	D
125	226	131



Item No.: RWGS-SH007

■ CLAMP

Nom Size	D	H	A
125	131.0	171.5	142.0

Piping

PVC Rainwater Gutter & Fitting



140mm Rainwater System Components



Item No.: RWGS-SH002

TEE

Nom Size	d1	d2	d3	d4	H	L	A
125	74.4	80	131	136.6	189.3	43	169



Item No.: RWGM-SH001

RAIN GUTTER

Nom Size	d1	d2	d3	d4	H1	H2
140	140	143.6	14.7	11.1	77.5	149.3



Item No.: RWGS-SH005

END CAP

Nom Size	d1	d2	d3	H	A
125	125.8	131	136.2	99.3	160.7



Item No.: RWGM-SH003

COUPLING

Nom Size	D	H	A
140	145	151	186



Item No.: RWGM-SH004

ANGLE CONNECTOR

Nom Size	H	D
140	245	145



Item No.: RWGM-SH005

END CAP

Nom Size	d1	d2	d3	H	A
140	139	145	151	110	176



Item No.: RWGM-SH007

CLAMP

Nom Size	D	H	A
140	145	187.5	152



Item No.: RWGM-SH002

TEE

Nom Size	d1	d2	d3	d4	H	L	A
140	77	82	145	151	226	45	186



PVC Rainwater Gutter & Fitting

170mm Rainwater System Components



Item No.: RWGL-SH001

RAIN GUTTER

Nom Size	d1	d2	d3	d4	H1	H2
170	170	174	16.2	12.2	93.2	180.2



Item No.: RWGL-SH002

TEE

Nom Size	d1	d2	d3	d4	H	L
170	94.4	100	176.2	181.8	159	48



Item No.: RWGL-SH003

COUPLING

Nom Size	d1	d2	H
170	176.2	181.8	196



Item No.: RWGL-SH004a

ANGLE CONNECTOR LEFT

Nom Size	H	L	D
170	277.2	60	176.2



Item No.: RWGL-SH004b

ANGLE CONNECTOR RIGHT

Nom Size	H	L	D
170	263	60	176.2



Item No.: RWGL-SH005

END CAP LEFT

Nom Size	d1	d2	H
170	176.2	181.8	196



Item No.: RWGL-SH006

END CAP RIGHT

Nom Size	d1	d2	H
170	176.2	181.8	196



Item No.: RWGL-SH007

CLAMP

Nom Size	D	H
170	176.2	206.7

Piping

PVC Rainwater Gutter & Fitting



5.2" Square Rainwater System Components

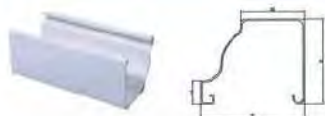

Item No.: RWGA-SH001

RAIN GUTTER

Nom Size	D1	D2	H	h1
5.2"	138	90	105	21

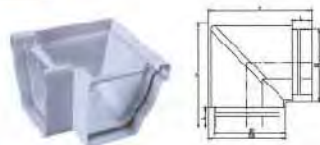

Item No.: RWGA-SH004b

90° OUTSIDE CORNER

Nom Size	H	D1	D2	L
5.2"	180	86	135	37.5



Item No.: RWGA-SH006

RECTANGLE PIPE

Nom Size	D	d
5.2"	86	63

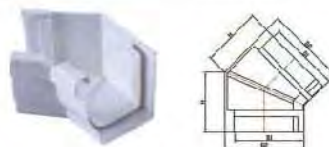

Item No.: RWGA-SH008a

135° INSIDE CORNER

Nom Size	D1	D2	H
5.2"	105	132	105



Item No.: RWGA-SH005a

LEFT END CAP

Nom Size	D	d
5.2"	136	109



Item No.: RWGA-SH008b

135° OUTSIDE CORNER

Nom Size	D1	D2	H
5.2"	105	132	105



Item No.: RWGA-SH005b

RIGHT END CAP

Nom Size	D	d
5.2"	136	109

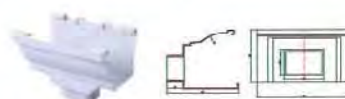

Item No.: RWGA-SH002

TEE

Nom Size	A1	A2	H1	H2	D	L1	L2
5.2"	219	152	173	35	100	79	58

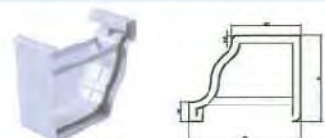

Item No.: RWGA-SH003

COUPLING

Nom Size	D1	D2	H	h1	h2
5.2"	135	90	108	27	5

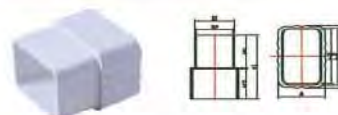

Item No.: RWGA-SH009

COUPLING OF PIPE

Nom Size	A	L1	L2	L3	D1	D2	H1	H2	H3
5.2"	65.5	88	80	76	56	52	90	45	43



Item No.: RWGA-SH004a

90° INSIDE CORNER

Nom Size	H	D1	D2	L
5.2"	180	86	135	37.5



Item No.: RWGA-SH010

65° DIVERTER

Nom Size	D	d	D1	d1	l1	l2
5.2"	67	63	57	53	41	35



PVC Rainwater Gutter & Fitting

5.2" Square Rainwater System Components

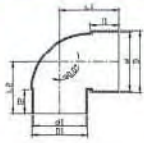

Item No.: RWGA-SH011

90° DIVERTER

Nom Size	D	d	D1	d1	L1	L2	H	I2
5.2"	67	63	57	53	73.5	64.5	41	35



Item No.: RWGA-SH018

SKEW TEE

Nom Size	D	d	D1	d1	H	L1	L2	H	I2
5.2"	90	86	80	76	198	126.6	120.2	45	35

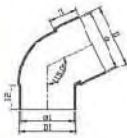

Item No.: RWGA-SH012

65° ELBOW

Nom Size	D	d	D1	d1	L1	L2	H	I2
5.2"	91	86	80	76	41	35		

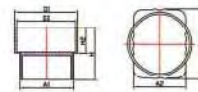

Item No.: RWGA-SH019

CONVERSION JOINT

Nom Size	A1	A2	L	H1	H2	D1	D2
5.2"	67.5	65.5	88	66	33	80	75

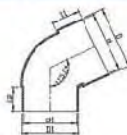

Item No.: RWGA-SH013

90° ELBOW

Nom Size	D	d	D1	d1	L1	L2	H	I2
5.2"	91	86	80	76	85	57	41	35

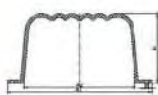

Item No.: RWGA-SH014

CLIP

Nom Size	A1	A2	H	D
5.2"	125	88.5	61.8	5



Item No.: RWGA-SH015

GUTTER HANGER-SINGLE HOLE

Nom Size	A	H
5.2"	60	131

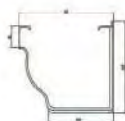

Item No.: RWGA-SH007

CLAMP

Nom Size	D1	D2	H1	H2
5.2"	145	101	22	132



Piping

PVC Rainwater Gutter & Fitting



7" Square Rainwater System Components



Item No.: RWGB-SH001

RAIN GUTTER

Nom Size	A	H	D
7"	76	148	100



Item No.: RWGB-SH004b

90° OUTSIDE CORNER

Nom Size	H	D1	D2	L
7"	220	134.2	156.5	51.5

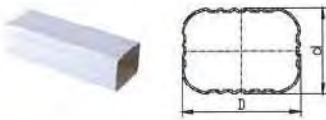

Item No.: RWGB-SH006

RECTANGLE PIPE

Nom Size	D1	d
7"	100	80



Item No.: RWGB-SH008a

135° INSIDE CORNER

Nom Size	D1	D2	H
7"	140	160	120



Item No.: RWGB-SH005a

LEFT END CAP

Nom Size	D1	d
7"	100	80



Item No.: RWGB-SH008b

135° OUTSIDE CORNER

Nom Size	D1	D2	H
7"	137	154	120



Item No.: RWGB-SH005b

RIGHT END CAP

Nom Size	D1	d
7"	100	80

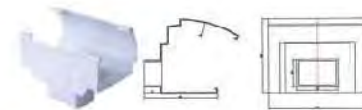

Item No.: RWGB-SH002

TEE

Nom Size	A1	A2	H1	H2	D	L1	L2
7"	231	156	155	49	150	94	71

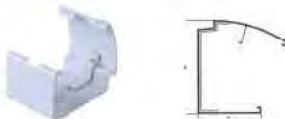

Item No.: RWGB-SH003

COUPLING

Nom Size	A	H	D
7"	83	156	150

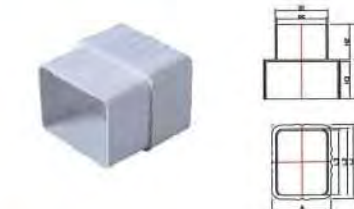

Item No.: RWGB-SH009

COUPLING OF PIPE

Nom Size	A	L1	L2	L3	D1	D2	H1	H2	H3
7"	82.5	105	94.5	90.5	72	68	105	50	52.5

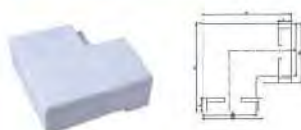

Item No.: RWGB-SH004a

90° INSIDE CORNER

Nom Size	H	D1	D2	L
7"	220	135	157	51.5



PVC Rainwater Gutter & Fitting

7" Square Rainwater System Components

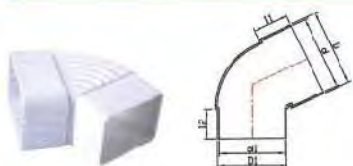

Item No.: RWGB-SH010

65° DIVERTER

Nom Size	D	d	D1	d1	I1	I2
7"	83	79	73	69	54	50

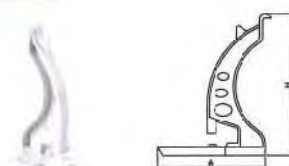

Item No.: RWGB-SH007

U HANGER

Nom Size	A	H
7"	87	151

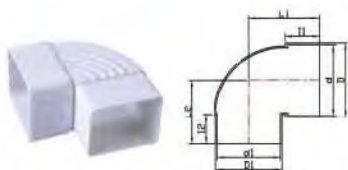

Item No.: RWGB-SH011

90° DIVERTER

Nom Size	D	d	D1	d1	L1	L2	I1	I2
7"	83	79	73	69	93.5	88.5	54	50



Item No.: RWGB-SH019

CONVERSION JOINT

Nom Size	A1	A2	L	H1	H2	D1	D2
7"	105	105	82.5	95.5	45.5	80	75

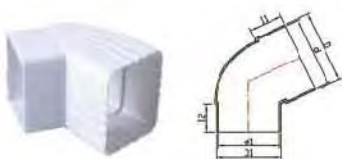

Item No.: RWGB-SH012

65° ELBOW

Nom Size	D	d	D1	d1	I1	I2
7"	105	101	94	90	54	50



Item No.: RWGB-SH013

90° ELBOW

Nom Size	D	d	D1	d1	L1	L2	I1	I2
7"	105	101	94	90	106	98.5	54	50



Item No.: RWGB-SH014

CLIP

Nom Size	A1	A2	H	D
7"	141.6	106.8	71	5



125mm Square Rainwater System Components



Item No.: RWGF-SH001

SQUARE RAIN GUTTER

Nom Size	D	H
125	129.1	73.58

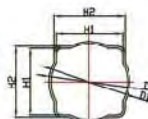

Item No.: RWGF-SH007

SQUARE RAIN PIPE

Nom Size	H1	H2	D1	D2
74	61	65	70	74

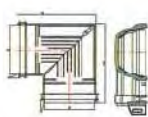

Item No.: RWGF-SH004

SQUARE ELBOW

Nom Size	D	H
125	128.7	208.02

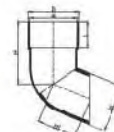

Item No.: RWGF-SH009

SQUARE 45 ELBOW

Nom Size	D	d	D1	H	L	H1
74	79	74.5	74	98	42	61.7



Item No.: RWGF-SH005

SQUARE END CAP

Nom Size	A	H
125	148.11	85.27

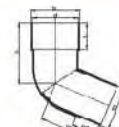

Item No.: RWGF-SH008

SQUARE 45 ELBOW M/F

Nom Size	D	d	D1	H	L	H1	H2
74	79	74.5	70	98	42	93.5	39.5

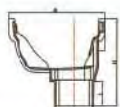

Item No.: RWGF-SH002

SQUARE TEE

Nom Size	A	D	d	H	L
125	148.51	60.17	56	135.8	38

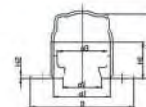

Item No.: RWGF-SH011

SQUARE U CLAMP

Nom Size	D	d1	d2	d3	H	H1	H2
74	134	74	50	65	82.7	47	4.5



Item No.: RWGF-SH006

SQUARE CLAMP

Nom Size	A	H
125	105.3	130.09

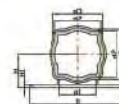

Item No.: RWGF-SH010

SQUARE COUPLING M/F

Nom Size	D	d1	d2	d3	H	H1
74	134.5	52	65	70	47.5	4.5



Item No.: RWGF-SH003

SQUARE COUPLING

Nom Size	A	D	D1	H
125	104.6	85.13	121	130.09



Polypropylene Random (PPR)

PPR (polypropylene random) is known as random copolymer polypropylene (PPR), too. Its products have good toughness, high strength, excellent processing performance, good creep resistance in high temperature. It can be widely used in the production of pipe, sheet, daily necessities, packaging materials, household electric appliance parts and various films.

Polyethylene (PP): For PP and other components like grease are all from Sinopec. All these will enhance pipe's stability and flexibility, and bring smooth inner wall and glossy surface.

Polyethylene-Random (PPR): We import PPR from Korean Hyosung. It's the best material of PPR in the world.

Color Masterbatch: German Bayer.

5 Years: no fading under extremely hard light.

8 Years: no fading at seaside under high salinity and hard light.

UV-Proof Component: Switzerland Clariant Chemicals.

Imported UV-proof can lengthen the usage life, lessen damage.

PP-R e as a new pipe has the following characteristics:

1. Corrosion-resistant, non-scaling, hygiene, non-toxic.
2. High temperature resistance, high pressure resistance, long usage time. The long-term working temperature of PP-R pipe is up to 95℃, and short-term working temperature is up to 120℃. Under 70℃ working temperature and 1.2MPa working pressure, the usage time will be 50 years.
3. Lightweight, high strength, fluid resistance.
4. Convenient but solid connection. PPR pipes and fittings can use electric welder and heat welder for connection and the connection area is stronger than non-connected area.

Application

1. Hot and cold water systems, including central heating system.
2. Building heating system, including floor, wall and radiant heating system.
3. Drinkable pure water supply system.
4. Central air conditioning system.
5. Other transfer or discharge chemical products industrial piping systems.



Welder



Cutter

Piping

Polypropylene Random (PPR)

PN12.5 Cold Water



Size x Wall Thickness(mm):
 20x2.0mm
 25x2.3mm
 32x3.0mm
 40x3.7mm
 50x4.6mm
 63x5.8mm
 75x6.9mm
 90x8.2mm
 110x10.1mm
 160x14.6mm

PN16 Cold Water



Size x Wall Thickness(mm):
 20x2.3mm
 25x2.8mm
 32x3.6mm
 40x4.5mm
 50x5.6mm
 63x7.1mm
 75x8.4mm
 90x10.1mm
 110x12.3mm
 160x17.8mm

PN20 Hot Water



Size x Wall Thickness(mm):
 20x2.8mm
 25x3.5mm
 32x4.4mm
 40x5.5mm
 50x6.9mm
 63x8.6mm
 75x10.1mm
 90x12.3mm
 110x15.3mm
 160x21.9mm

PN25 Hot Water



Size x Wall Thickness(mm):
 20x3.4mm
 25x4.2mm
 32x5.4mm
 40x6.7mm
 50x8.3mm
 63x10.5mm
 75x12.3mm
 90x15.0mm
 110x18.3mm

Coupling



Size x Wall Thickness(mm):
 S20mm
 S25mm
 S32mm
 S40mm
 S50mm
 S63mm
 S75mm
 S90mm
 S110mm
 S160mm

Reducing Socket



Size x Wall Thickness(mm):
 S25x20mm
 S32x20mm
 S32x25mm
 S40x20mm
 S40x25mm
 S40x32mm
 S50x20mm
 S50x25mm
 S50x32mm
 S50x40mm
 S63x20mm

Elbow



Size x Wall Thickness(mm):
 L20mm
 L25mm
 L32mm
 L40mm
 L50mm
 L63mm
 L75mm
 L90mm
 L110mm
 L160mm

90Deg Nipple Elbow



Size x Wall Thickness(mm):
 L20mm
 L25mm
 L32mm

S63x25mm S90x40mm
 S63x32mm S90x50mm
 S63x40mm S90x63mm
 S63x50mm S90x75mm
 S75x20mm S110x25mm
 S75x25mm S110x32mm
 S75x32mm S110x40mm
 S75x40mm S110x50mm
 S75x50mm S110x63mm
 S75x63mm S110x75mm
 S90x25mm S110x90mm
 S90x32mm S160x110mm

Long Elbow



Size x Wall Thickness(mm):
 L20mm
 L25mm

45Deg Elbow



Size x Wall Thickness(mm):
 L20mm
 L25mm
 L32mm
 L40mm
 L50mm
 L63mm
 L75mm
 L90mm
 L110mm
 L160mm

Reducing Tee



Size x Wall Thickness(mm):
 T25x20x25mm
 T32x20x32mm
 T32x25x32mm
 T40x20x40mm
 T40x25x40mm
 T40x32x40mm
 T50x20x50mm
 T50x25x50mm
 T50x32x50mm
 T50x40x50mm
 T63x20x63mm
 T63x25x63mm

Reducing Elbow



Size x Wall Thickness(mm):
 L25x20mm
 L32x30mm
 L32x25mm
 L40x20mm
 L40x25mm
 L40x32mm
 L50x20mm
 L50x25mm
 L50x32mm
 L50x40mm
 L63x20mm
 L63x25mm
 L63x32mm
 L63x40mm
 L63x50mm

Equal Tee



Size x Wall Thickness(mm):
 T20mm
 T25mm
 T32mm
 T40mm
 T50mm
 T63mm
 T75mm
 T90mm
 T110mm
 T160mm

T63x32x63mm T90x63x90mm
 T63x40x63mm T90x75x90mm
 T63x50x63mm T110x20x110mm
 T75x20x75mm T110x25x110mm
 T75x25x75mm T110x32x110mm
 T75x32x75mm T110x40x110mm
 T75x40x75mm T110x50x110mm
 T75x50x75mm T110x63x110mm
 T75x63x75mm T110x75x110mm
 T90x32x90mm T110x90x110mm
 T90x40x90mm T160x90x160mm
 T90x50x90mm T160x110x160mm

Regular Clip



Size x Wall Thickness(mm):
 ø16
 ø20
 ø25
 ø32

Special Reducing Tee



Size x Wall Thickness(mm):
 T25x20x20mm
 T25x25x20mm
 T32x25x25mm
 T32x20x25mm
 T32x25x20mm
 T32x32x25mm

Straight Cross



Size x Wall Thickness(mm):
 20mm
 25mm
 32mm
 40mm
 50mm
 63mm

Polypropylene Random (PPR)

<p>End Cap</p> 	<p>Size x Wall Thickness(mm): 20mm 25mm 32mm 40mm 50mm 63mm 75mm 90mm 110mm</p>	<p>Female Socket</p> 	<p>Size x Wall Thickness(mm): S20x3/8F S20x1/2F S20x3/4F S25x1/2F S25x3/4F S32x1/2F S32x3/4F S32x1F S40x11/4F S50x11/2F S63x2F S75x2 1/2F S90x3F S110x4F</p>	<p>Male Socket</p> 	<p>Size x Wall Thickness(mm): S20x3/8M S20x1/2M S20x3/4M S25x1/2M S25x3/4M S32x1/2M S32x3/4M S32x1M S40x11/4M S50x11/2M S63x2M S75x2 1/2M S90x3M S110x4M</p>
<p>Female Elbow</p> 	<p>Size x Wall Thickness(mm): L20x1/2F L20x3/4F L25x1/2F L25x3/4F L32x1/2F L32x3/4F L32x1F L40x11/4F L50x11/2F L63x2F</p>	<p>Male Elbow</p> 	<p>Size x Wall Thickness(mm): L20x1/2M L20x3/4M L25x1/2M L25x3/4M L32x1/2M L32x3/4M L32x1M L40x11/4M L50x11/2M L63x2M</p>	<p>Female Elbow With Pedestal</p> 	<p>Size x Wall Thickness(mm): ZL20x1/2F ZL20x3/4F ZL25x1/2F ZL25x3/4F ZL32x1F</p>
<p>Male Elbow With Pedestal</p> 	<p>Size x Wall Thickness(mm): ZL20x1/2M ZL20x3/4M ZL25x1/2M ZL25x3/4M ZL32x1FM</p>	<p>Female Tee</p> 	<p>Size x Wall Thickness(mm): T20x1/2F T20x3/4F T25x1/2F T25x3/4F T32x1/2F T32x3/4F T32x1F T40x11/4F T50x11/2F T63x2F</p>	<p>Male Tee</p> 	<p>Size x Wall Thickness(mm): T20x1/2M T20x3/4M T25x1/2M T25x3/4M T32x1/2M T32x3/4M T32x1M T40x11/4M T50x11/2M T63x2M</p>
<p>Female Flexible(Lighter)</p> 	<p>Size x Wall Thickness(mm): H20x1/2F H25x3/4F H32x1F</p>	<p>Male Flexible(Lighter)</p> 	<p>Size x Wall Thickness(mm): H20x1/2M H25x3/4M H32x1M</p>	<p>Female Union</p> 	<p>Size x Wall Thickness(mm): H32x1F H40x11/4F H50x11/2F H63x2F</p>
<p>Special Female Union</p> 	<p>Size x Wall Thickness(mm): H20x3/4F H20x1"F H25x1/2F H25x1"F H32x3/4F H32x11/4F</p>	<p>Male Union</p> 	<p>Size x Wall Thickness(mm): H20x1/2M H25x3/4M H32x1M H40x11/4M H50x11/2M H63x2M</p>	<p>Special Male Union</p> 	<p>Size x Wall Thickness(mm): H20x3/4M H20x1"M H25x1/2M H25x1"M H32x3/4M H32x11/4M</p>
<p>Double Union</p> 	<p>Size x Wall Thickness(mm): H20x1/2 H25x3/4 H32x1 H40 H50 H63x2</p>	<p>PPR Union</p> 	<p>Size x Wall Thickness(mm): H20 H25 H32 H40 H50 H63</p>	<p>Flange</p> 	<p>Size x Wall Thickness(mm): 40mm 50mm 63mm 75mm 90mm 110mm 160mm</p>

Piping

Polypropylene Random (PPR)

Short-Bypass Bend



Size x Wall Thickness(mm):
20mm
15mm
32mm

Bridge



Size x Wall Thickness(mm):
20mm
15mm
32mm

Long-Bypass Bend



Size x Wall Thickness(mm):
20x2.8mm
25x3.5mm
32x4.4mm

Plug



Size x Wall Thickness(mm):
1/2"mm
3/4"mm
1"mm

Test Plug



Size x Wall Thickness(mm):
1/2"mm

Plastic Ball Valve



Size x Wall Thickness(mm):
20mm
25mm
32mm
40mm
50mm
63mm

Double Brass Ball Valve



Size x Wall Thickness(mm):
20mm
25mm
32mm
40mm
50mm
63mm

Male Brass Ball Valve



Size x Wall Thickness(mm):
20x1/2M
25x3/4M
32x1" M

Female Brass Ball Valve



Size x Wall Thickness(mm):
20x1/2F
25x3/4F
32x1" F

Stop Valve



Size x Wall Thickness(mm):
20mm
25mm
32mm
40mm
50mm
63mm
75mm
90mm
110mm

Heavy Stop Valve



Size x Wall Thickness(mm):
20mm
25mm
32mm
40mm
50mm
63mm
75mm
90mm

Triangle Concealed Valve



Size x Wall Thickness(mm):
20mm
25mm
32mm

New Luxury Stop Valve



Size x Wall Thickness(mm):
20mm
25mm
32mm

Concealed Valve



Size x Wall Thickness(mm):
20mm
25mm
32mm

Luxury Ball Valve



Size x Wall Thickness(mm):
20mm
25mm
32mm

New Luxury Stop Valve



Size x Wall Thickness(mm):
20mm
25mm
32mm

Buckle With Seat



Size x Wall Thickness(mm):
ø16A
ø18
ø20
ø25
ø32

Low-Foot Clamp



Size x Wall Thickness(mm):
ø16
ø20
ø25
ø32
ø40

The Strength of PPH Pipe

Homopolymer-PP (Homo-PP): Homo-PPH is the key component of PPH pipes. It is for polymerizing Polyethylene (PP). We import it from Korea. Korea is famous for PP raw materials, like SK (www.skchem.com). Good Homo-PP will increase the connection and stability of raw materials.

Polyethylene (PP): For PP and other components like grease are all from Sinopec. All these will enhance pipe's stability and flexibility, and bring smooth inner wall and glossy surface.

Color Masterbatch: German Bayer.

5 Years: no fading under extremely hard light.

8 Years: no fading at seaside under high salinity and hard light.

UV-Proof Component: Switzerland Clariant Chemicals.

Imported UV-proof can lengthen the usage life, lessen damage.

PPH Pipe Structure

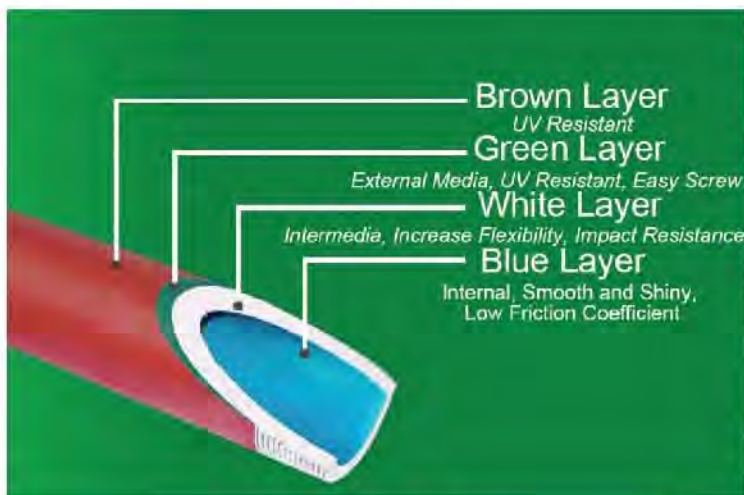

PPH Pipe Raw Materials



Working Performance of Pipe

Temperature(°C)	Usage Time (year)	Safety Factor	Pressure (Bar)
10-20	10	1.9	27.5
	25	1.9	26.7
	50	1.9	25.9
30	10	1.9	23.2
	25	1.9	22.4
	50	1.9	21.9
40	10	1.9	19.7
	25	1.9	18.9
	50	1.9	18.4
50	10	1.9	16.5
	25	1.9	16
	50	1.9	15.5
60	10	1.9	13.9
	25	1.9	13.3
	50	1.9	12.9
70	10	1.9	11.6
	25	1.9	9.9
	50	1.9	8.5
80	10	1.9	8
	25	1.9	6.4
90	10	1.9	7.7

Safety Factor | 3

Notes: The graph gives the life time in years (as per the scale).

50 Years means: Continuous use without gap
ie. 24hrx360 Daysx50 Years.

Normal Conditions in connections of the bathrooms and the kitchens are: Pressure = 3 to 6 Bar;
Temperature = 40°C to 70°C.

Working Durability of it is 50 years.

Piping

PPH Pipe Series

<p>PP Female Tee(H01)New</p> 	<p>Size x Wall Thickness(mm): 1/2"mm 3/4"mm 1"mm 1-1/4"mm 1-1/2"mm 2"mm</p>	<p>PP Female Elbow(H02)New</p> 	<p>Size x Wall Thickness(mm): 1/2"mm 3/4"mm 1"mm 1-1/4"mm 1-1/2"mm 2"mm</p>	<p>PP Universal Union(H03)New</p> 	<p>Size x Wall Thickness(mm): 1/2"mm 3/4"mm 1"mm 1-1/4"mm 1-1/2"mm 2"mm</p>
<p>PP Female Coupling(H04)New</p> 	<p>Size x Wall Thickness(mm): 1/2"mm 3/4"mm 1"mm 1-1/4"mm 1-1/2"mm 2"mm</p>	<p>PP Nipple</p> 	<p>Size x Wall Thickness(mm): 1/2"mm 3/4"mm 1"mm 1-1/4"mm 1-1/2"mm 2"mm</p>	<p>PP 45Deg Elbow</p> 	<p>Size x Wall Thickness(mm): 1/2"mm 3/4"mm 1"mm</p>
<p>PP Elbow With Brass(H05)</p> 	<p>Size x Wall Thickness(mm): 1/2"mm</p>	<p>PP Female Big Elbow(H06)</p> 	<p>Size x Wall Thickness(mm): 3/4"mm</p>	<p>PP Male Big Elbow(H09)</p> 	<p>Size x Wall Thickness(mm): 1/2"mm 3/4"mm 1"mm</p>
<p>BS Female Elbow</p> 	<p>Size x Wall Thickness(mm): 1/2"mm 3/4"mm 1"mm</p>	<p>BS Female Tee</p> 	<p>Size x Wall Thickness(mm): 1/2"mm 3/4"mm 1"mm</p>	<p>Male Coupling(C05)</p> 	<p>Size x Wall Thickness(mm): 1/2"mm 3/4"mm 1"mm 1-1/4"mm 1-1/2"mm 2"mm</p>
<p>Female & Male Adapter(C07)</p> 	<p>Size x Wall Thickness(mm): 3/4"x1/2"mm 1"x1/2"mm 1"x3/4"mm 1-1/4"x3/4"mm 1-1/4"x1"mm 1-1/2"x1/4"mm 1-1/2"x3/4"mm 1-1/2"x1"mm 2"x1"mm 2"x1"-1/4"mm 2"x1-1/2"mm</p>	<p>Male Plug(C08)</p> 	<p>Size x Wall Thickness(mm): 1/2"mm 3/4"mm 1"mm 1-1/4"mm 1-1/2"mm 2"mm</p>	<p>Male Reducer(C17)</p> 	<p>Size x Wall Thickness(mm): 3/4"x1/2"mm 1"x1/2"mm 1"x3/4"mm</p>
<p>Female Reducer(C09)</p> 	<p>Size x Wall Thickness(mm): 3/4"x1/2"mm 1"x1/2"mm 1"x3/4"mm</p>	<p>Male & Female Elbow(C06)</p> 	<p>Size x Wall Thickness(mm): 1/2"mm 3/4"mm 1"mm 1-1/4"mm 1-1/2"mm 2"mm</p>	<p>Female Cap</p> 	<p>Size x Wall Thickness(mm): 1/2"mm 3/4"mm 1"mm 1-1/4"mm 1-1/2"mm 2"mm</p>

Chlorinated Poly (Vinyl Chloride) (CPVC)

Chlorinated Poly (Vinyl Chloride) (CPVC) is a thermoplastic pipe and fitting material made with CPVC compounds meeting the requirements of ASTM Class 23447 as defined in ASTM Specification D1784. CPVC applications are for potable water distribution, corrosive fluid handling in industry, and fire suppression systems.

CPVC piping systems are:

- Environmentally friendly
- Provide long service life
- Easy to install and handle
- Corrosion resistant
- Cost effective
- Widely accepted by codes

CPVC pipe for plumbing systems is manufactured by extrusion in sizes " through 2" copper tube size (CTS) dimensions. The CTS plumbing products are made to copper tube outside diameter dimensions, in accordance with ASTM D-2846 specifications, and have an SDR 11 wall thickness. The pressure ratings of the CTS SDR 11 systems are 400 psi (pounds per square inch) at 73 F and 100 psi at 180 F. CPVC plumbing pipe is sold in both straight lengths and (in small diameters) coils.

Usage/Application

CPVC piping which is suitable for hot and cold water distribution has a 400 psi pressure rating at room temperature, and a 100 psi pressure rating at 180 F.

CPVC materials are resistant to many everyday household chemicals.

Since CPVC materials do not support combustion, they cannot burn without an external fuel source. This property makes CPVC pipe an attractive alternative to steel and copper pipe for fire sprinkler applications. CPVC fire sprinkler piping systems are approved for light hazard applications and for use in single and multifamily dwellings. Installation shall be in accordance with the NFPA Section 13, 13D, and 13R.

Code Status

CPVC piping for potable hot and cold water distribution system is recognized in all model plumbing codes.

Also, CPVC plumbing pipe is safe for installation in return air plenums; however, the installation must be approved by the local jurisdiction. Even though CPVC is considered a combustible material it will not burn without a significant external flame source. Once the flame source is removed CPVC will not sustain combustion. Testing indicates that water filled CPVC in diameters 3" or less will pass the 25/50 flame smoke developed requirements for non-metallic material in return air plenums.

CPVC fire sprinkler pipe tested and listed in accordance with UL 1887, "Fire Test of Plastic Sprinkler Pipe for Flame and Smoke Characteristics," meets the requirements of NFPA 90A for installation in return air plenums.

CPVC fire sprinkler pipe tested and listed in accordance with UL 1887, "Fire Test of Plastic Sprinkler Pipe for Flame and Smoke Characteristics," meets the requirements of NFPA 90A for installation in return air plenums.

Piping

Chlorinated Poly (Vinyl Chloride) (CPVC)

CPVC fire sprinkler pipe tested and listed in accordance with UL 1887, "Fire Test of Plastic Sprinkler Pipe for Flame and Smoke Characteristics," meets the requirements of NFPA 90A for installation in return air plenums.

Availability

CPVC pipe and fittings are produced by many manufacturers, and are available in Schedule 40 and Schedule 80 dimensions, as well as CPVC tubing which is suitable for potable hot and cold water distribution. The tubing is based on copper tube sizes (OD) and IPS pipe (OD), with SDR 11 wall thicknesses.

Marking

CPVC pipe must be labeled at not more than 1.5 meters (5 feet) intervals as follows:

1. The manufacturer's name or trademark
2. The standard to which it conforms
3. Pipe size
4. Resin type or cell class according to ASTM D-1784, e.g. CPVC 23447
5. Pressure rating
6. SDR number or Schedule number
7. If the pipe is for potable water, a laboratory seal or mark attesting to suitability for potable water

CPVC Hot & Cold Water Supply Series

<p>Coupling(M01)</p> 	<p>Size x Wall Thickness(mm): 1/2"mm 3/4"mm 1"mm 1-1/4"mm 1-1/2"mm 2"mm</p>	<p>90 Deg Elbow(M02)</p> 	<p>Size x Wall Thickness(mm): 1/2"mm 3/4"mm 1"mm 1-1/4"mm 1-1/2"mm 2"mm 3/4"x1/2"mm</p>	<p>Tee(M03)</p> 	<p>Size x Wall Thickness(mm): 1/2"mm 3/4"mm 1"mm 1-1/4"mm 1-1/2"mm 2"mm</p>
<p>45 Deg Elbow(M04)</p> 	<p>Size x Wall Thickness(mm): 1/2"mm 3/4"mm 1"mm 1-1/4"mm 1-1/2"mm 2"mm</p>	<p>Reducing Coupling(M07)</p> 	<p>Size x Wall Thickness(mm): 3/4"x1/2"mm 1"x1/2"mm 1"x3/4"mm 1-1/4"x3/4"mm 1-1/4"x1"mm 1-1/2"x1"mm 1-1/2"x1-1/4"mm 2"x1-1/4"mm 2"x1-1/2"mm</p>	<p>Reducing Tee(M10)</p> 	<p>Size x Wall Thickness(mm): 3/4"x1/2"mm 1"x1"x1/2"mm 1"x1"x3/4"mm 1-1/4"x3/4"mm 1-1/4"x1"mm</p>
<p>Bush(M06)</p> 	<p>Size x Wall Thickness(mm): 3/4"x1/2"mm 1"x1/2"mm 1"x3/4"mm 1-1/4"x3/4"mm 1-1/4"x1"</p>	<p>End Cap(M11)</p> 	<p>Size x Wall Thickness(mm): 1/2"mm 3/4"mm 1"mm 1-1/4"mm 1-1/2"mm 2"mm</p>	<p>Union(M09)</p> 	<p>Size x Wall Thickness(mm): 1/2"mm 3/4"mm 1"mm 1-1/4"mm 1-1/2"mm 2"mm</p>

CPVC Hot & Cold Water Supply Series



Size x Wall Thickness(mm):
1/2"mm
3/4"mm
1"mm
1-1/4"mm
1-1/2"mm
2"mm



Size x Wall Thickness(mm):
1/2"mm
3/4"mm
1"mm
1-1/4"mm
1-1/2"mm
2"mm



Size x Wall Thickness(mm):
1/2"mm
3/4"mm
1"mm
1-1/4"mm
1-1/2"mm
2"mm



Size x Wall Thickness(mm):
1/2"mm
3/4"mm
1"mm
1-1/4"mm
1-1/2"mm
2"mm



Size x Wall Thickness(mm):
1/2"mm
3/4"mm
1"mm
3/4"x1/2"mm



Size x Wall Thickness(mm):
1/2"mm
3/4"mm
1"mm
3/4"x1/2"mm
1"x1/2"mm



Size x Wall Thickness(mm):
1/2"x1/2"mm
3/4"x1/2"mm
3/4"x3/4"mm
1"x1/2"mm



Size x Wall Thickness(mm):
1/2"x1/2"mm
3/4"x1/2"mm
1"x1"x1/2"mm



Size x Wall Thickness(mm):
1/2"mm
3/4"mm
1"mm
1-1/4"mm
1-1/2"mm
2"mm



Size x Wall Thickness(mm):
1/2"mm
3/4"mm
1"mm
1-1/4"mm
1-1/2"mm
2"mm



Size x Wall Thickness(mm):
1/2"mm
3/4"mm
1"mm
1-1/4"mm
1-1/2"mm
2"mm



Size x Wall Thickness(mm):
3/4"mm
1"mm
1-1/4"mm
2"mm



Size x Wall Thickness(mm):
1/2"x1/2"mm



Size:
1/2"x1.73mm
3/4"x2.03mm
1"x2.6mm
1-1/4"x3.3mm
1-1/2"x3.81mm
2"x4.85mm
Weight(G/3M)
360
630
1029
1560
2160
3465



Size:
1/2"x1.51mm
3/4"x1.73mm
1"x2.03mm
1-1/4"x2.59mm
1-1/2"x3.06mm
2"x4.0mm
Weight(G/3M)
294
510
804
1230
1722
2775

Electronics

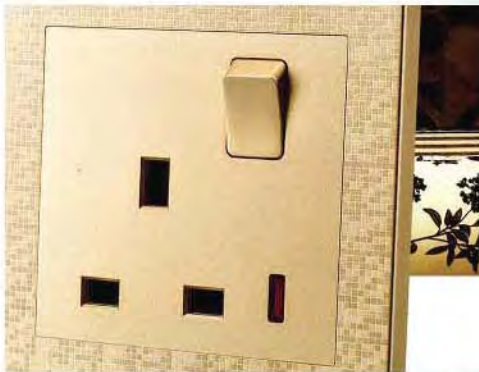
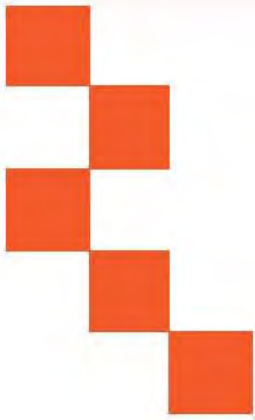

- Voltage Stabilizer
- Switches

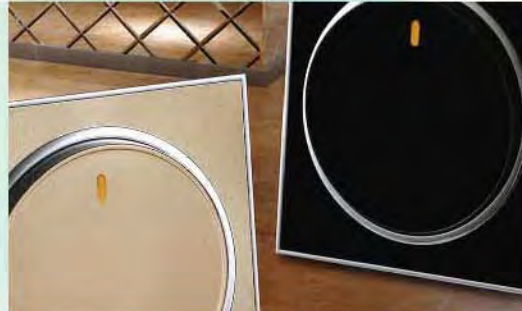

Voltage Stabilizer

Voltage Stabilizer is also called Automatic Voltage Stabilizer or AC Voltage Stabilizer or Voltage Regulator.

Actually an automatic voltage stabilizer is designed to automatically maintain a constant voltage level, with protections of equipment against voltage surges, over voltage, under voltage, smoothing impulsive noise.

It regulates the fluctuating input power voltage and output constant voltage, such as 220V or 230V for single phase and 380V or 400V for three phase. The fluctuating range in different countries differs a lot. For most African countries, the voltage fluctuates widely from 100V to 270V, or even lower than 90V. So, if your countries suffer unstable voltage, you must equip voltage stabilizers for your appliances or a big AVR for your whole house. The voltage stabilizer is always a Safe Guard for protecting residential use and the industrial use, where the electricity is unstable.

Currently supplying the below brands...

Nigeria: • NEXUS	Ghana: • KAPS
• EUROSONIG	
• NATURE POWER	
• MEGA	Tanzania: • BELTRON
• I POWER	
• MORE GOLD	
• GEEVOX	Kenya: • KINGCAND
• KAYSUN	
• M STAR	

500VA	4560
1000VA	2760
1500VA	2760
2000VA	2760
2000VA BIG	2168
3000VA	790 (w/master Ctn)
5000VA	790 (w/master Ctn)



Voltage Stabilizer

Automatic Voltage Regulator / Relay Type

FVR



PHR



FVR-SH500VA



FVR-SH1000VA



FVR-SH1500VA



PHR-SH500VA



PHR-SH1000VA



PHR-SH1500VA



FVR-SH2000VA



FVR-SH3000VA



FVR-SH5000VA



PHR-SH2000VA



PHR-SH3000VA



PHR-SH5000VA

OVR



PVR



OVR-SH500VA



OVR-SH1000VA



OVR-SH1500VA



PVR-SH500VA



PVR-SH1000VA



PVR-SH1500VA



OVR-SH2000VA



OVR-SH3000VA



OVR-SH5000VA



PVR-SH2000VA



PVR-SH3000VA



PVR-SH5000VA

Voltage Stabilizer

Automatic Voltage Regulator / Relay Type



SVR-SH500VA

SVR-SH1000VA

SVR-SH1500VA



IVR-SH500VA

IVR-SH1000VA

IVR-SH1500VA



SVR-SH2000VA

SVR-SH3000VA

SVR-SH5000VA



IVR-SH2000VA

IVR-SH3000VA

IVR-SH5000VA



NDR-SH500VA

NDR-SH1000VA

NDR-SH1500VA



XVR-SH500VA

XVR-SH1000VA

XVR-SH1500VA



NDR-SH2000VA

NDR-SH3000VA

NDR-SH5000VA



XVR-SH2000VA

XVR-SH3000VA

XVR-SH5000VA

Voltage Stabilizer

Automatic Voltage Regulator / Relay Type

JVR



EVR



JVR-SH500VA	JVR-SH1000VA	JVR-SH1500VA
JVR-SH2000VA	JVR-SH3000VA	JVR-SH5000VA

EVR-SH500VA	EVR-SH1000VA	EVR-SH1500VA
EVR-SH2000VA	EVR-SH3000VA	EVR-SH5000VA

AUR



TVR



AUR-SH500VA	AUR-SH1000VA	AUR-SH1500VA
AUR-SH2000VA	AUR-SH3000VA	AUR-SH5000VA

TVR-SH500VA	TVR-SH1000VA	TVR-SH1500VA
TVR-SH2000VA	TVR-SH3000VA	TVR-SH5000VA

Switch & Socket

SH1-Series



5 pins universal socket
Model No.: SH1-011
 13A/250V~
 10pcs/box 100pcs/ctn
 49.5x31.5x20cm³



Switched socket with neon
Model No.: SH1-012
 13A/250V~
 10pcs/box 100pcs/ctn
 49.5x31.5x20cm³

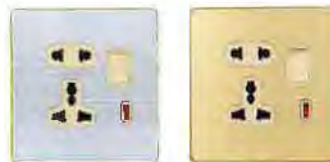

Switched socket with neon
Model No.: SH1-013
 13A/250V~
 10pcs/box 100pcs/ctn
 49.5x31.5x20cm³



13A switched socket with neon
Model No.: SH1-014
 13A/250V~
 10pcs/box 100pcs/ctn
 49.5x31.5x20cm³



15A switched socket with neon
Model No.: SH1-015
 15A/250V~
 10pcs/box 100pcs/ctn
 49.5x31.5x20cm³



15A switched socket
Model No.: SH1-016
 15A/250V~
 10pcs/box 100pcs/ctn
 49.5x31.5x20cm³



TV Socket
Model No.: SH1-017
 10pcs/box 100pcs/ctn
 49.5x31.5x20cm³



Computer Socket
 TEL Socket
Model No.: SH1-018
SH1-019
 10pcs/box 100pcs/ctn
 49.5x31.5x20cm³



1 gang 1 way switch
Model No.: SH1-001
 1 gang 2 ways switch
SH1-002
 16A/250V~
 10pcs/box 100pcs/ctn
 49.5x31.5x20cm³



2 gangs 1 way switch
Model No.: SH1-003
 2 gangs 2 ways switch
SH1-004
 16A/250V~
 10pcs/box 100pcs/ctn
 49.5x31.5x20cm³



3 gangs 1 way switch
Model No.: SH1-005
 3 gangs 2 ways switch
SH1-006
 16A/250V~
 10pcs/box 100pcs/ctn
 49.5x31.5x20cm³



4 gangs 1 way switch
Model No.: SH1-007
 4 gangs 2 ways switch
SH1-008
 16A/250V~
 10pcs/box 100pcs/ctn
 49.5x31.5x20cm³



Door bell switch
Model No.: SH1-009
 10A/250V~
 10pcs/box 100pcs/ctn
 49.5x31.5x20cm³



3 pins universal socket
Model No.: SH1-010
 13A/250V~
 10pcs/box 100pcs/ctn
 49.5x31.5x20cm³

Switch & Socket

SH2-Series



5 pins universal socket
Model No.: SH2-011
 13A/250V~
 10pcs/box 100pcs/ctn
 49.5x31.5x20cm³



Switched socket with neon
Model No.: SH2-012
 13A/250V~
 10pcs/box 100pcs/ctn
 49.5x31.5x20cm³



Switched socket with neon
Model No.: SH2-013
 13A/250V~
 10pcs/box 100pcs/ctn
 49.5x31.5x20cm³

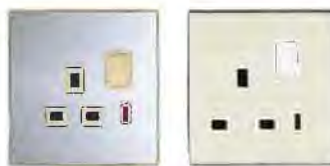

13A switched socket with neon
Model No.: SH2-014
 13A/250V~
 10pcs/box 100pcs/ctn
 49.5x31.5x20cm³



15A switched socket with neon
Model No.: SH2-015
 15A/250V~
 10pcs/box 100pcs/ctn
 49.5x31.5x20cm³



15A switched socket
Model No.: SH2-016
 15A/250V~
 10pcs/box 100pcs/ctn
 49.5x31.5x20cm³



TV Socket
Model No.: SH2-017
 10pcs/box 100pcs/ctn
 49.5x31.5x20cm³



Computer Socket
 TEL Socket
Model No.: SH2-018
SH2-019
 10pcs/box 100pcs/ctn
 49.5x31.5x20cm³



1 gang 1 way switch
 1 gang 2 ways switch
Model No.: SH2-001
SH2-002
 16A/250V~
 10pcs/box 100pcs/ctn
 49.5x31.5x20cm³



2 gangs 1 way switch
 2 gangs 2 ways switch
Model No.: SH2-003
SH2-004
 16A/250V~
 10pcs/box 100pcs/ctn
 49.5x31.5x20cm³



3 gangs 1 way switch
 3 gangs 2 ways switch
Model No.: SH2-005
SH2-006
 16A/250V~
 10pcs/box 100pcs/ctn
 49.5x31.5x20cm³



4 gangs 1 way switch
 4 gangs 2 ways switch
Model No.: SH2-007
SH2-008
 16A/250V~
 10pcs/box 100pcs/ctn
 49.5x31.5x20cm³

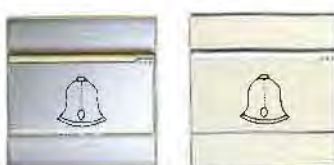

Door bell switch
Model No.: SH2-009
 10A/250V~
 10pcs/box 100pcs/ctn
 49.5x31.5x20cm³



3 pins universal socket
Model No.: SH2-010
 13A/250V~
 10pcs/box 100pcs/ctn
 49.5x31.5x20cm³

Switch & Socket

SH3-Series



1 gang 1 way switch
1 gang 2 ways switch

16A/250V~
10pcs/box 100pcs/ctn
49.5x31.5x20cm³

Model No.:
SH3-001
SH3-002



2 gangs 1 way switch
2 gangs 2 ways switch

16A/250V~
10pcs/box 100pcs/ctn
49.5x31.5x20cm³

Model No.:
SH3-003
SH3-004



3 gangs 1 way switch
3 gangs 2 ways switch

16A/250V~
10pcs/box 100pcs/ctn
49.5x31.5x20cm³

Model No.:
SH3-005
SH3-006



4 gang 1 way switch
4 gangs 2 ways switch

16A/250V~
10pcs/box 100pcs/ctn
49.5x31.5x20cm³

Model No.:
SH3-007
SH3-008



Door bell switch

10A/250V~
10pcs/box 100pcs/ctn
49.5x31.5x20cm³

Model No.:
SH3-009



3 pins universal socket

13A/250V~
10pcs/box 100pcs/ctn
49.5x31.5x20cm³

Model No.:
SH3-010



5 pins universal socket

13A/250V~
10pcs/box 100pcs/ctn
49.5x31.5x20cm³

Model No.:
SH3-011



Switched socket
with neon

13A/250V~
10pcs/box 100pcs/ctn
49.5x31.5x20cm³

Model No.:
SH3-012



13A switched socket
with neon

13A/250V~
10pcs/box 100pcs/ctn
49.5x31.5x20cm³

Model No.:
SH3-013



15A switched socket
with neon

15A/250V~
10pcs/box 100pcs/ctn
49.5x31.5x20cm³

Model No.:
SH3-014



15A switched socket

15A/250V~
10pcs/box 100pcs/ctn
49.5x31.5x20cm³

Model No.:
SH3-015



TV Socket

10pcs/box 100pcs/ctn
49.5x31.5x20cm³

Model No.:
SH3-016



Computer Socket
TEL Socket

10pcs/box 100pcs/ctn
49.5x31.5x20cm³

Model No.:
SH3-017
SH3-018



TV+TEL Socket
TV+Computer Socket

10pcs/box 100pcs/ctn
49.5x31.5x20cm³

Model No.:
SH3-019
SH3-020

Switch & Socket

SH4-Series



1 gang 1 way switch
1 gang 2 ways switch

16A/250V~
10pcs/box 100pcs/ctn
49.5x31.5x20cm³

Model No.:
SH4-001
SH4-002



2 gangs 1 way switch
2 gangs 2 ways switch

16A/250V~
10pcs/box 100pcs/ctn
49.5x31.5x20cm³

Model No.:
SH4-003
SH4-004



3 gangs 1 way switch
3 gangs 2 ways switch

16A/250V~
10pcs/box 100pcs/ctn
49.5x31.5x20cm³

Model No.:
SH4-005
SH4-006



4 gang 1 way switch
4 gangs 2 ways switch

16A/250V~
10pcs/box 100pcs/ctn
49.5x31.5x20cm³

Model No.:
SH4-007
SH4-008



Door bell switch

10A/250V~
10pcs/box 100pcs/ctn
49.5x31.5x20cm³

Model No.:
SH4-009



3 pins universal socket

13A/250V~
10pcs/box 100pcs/ctn
49.5x31.5x20cm³

Model No.:
SH4-010



5 pins universal socket

13A/250V~
10pcs/box 100pcs/ctn
49.5x31.5x20cm³

Model No.:
SH4-011



Switched socket
with neon

13A/250V~
10pcs/box 100pcs/ctn
49.5x31.5x20cm³

Model No.:
SH4-012



Switched socket
with neon

13A/250V~
10pcs/box 100pcs/ctn
49.5x31.5x20cm³

Model No.:
SH4-013



13A switched socket
with neon

13A/250V~
10pcs/box 100pcs/ctn
49.5x31.5x20cm³

Model No.:
SH4-014



15A switched socket
with neon

15A/250V~
10pcs/box 100pcs/ctn
49.5x31.5x20cm³

Model No.:
SH4-015



15A switched socket

15A/250V~
10pcs/box 100pcs/ctn
49.5x31.5x20cm³

Model No.:
SH4-016



TV Socket

10pcs/box 100pcs/ctn
49.5x31.5x20cm³

Model No.:
SH4-017



Computer Socket
TEL Socket

10pcs/box 100pcs/ctn
49.5x31.5x20cm³

Model No.:
SH4-018
SH4-019

Switch & Socket

SH5-Series



Need to choose install Box
 Note: The draft image of socket is just for your reference.
 120 and 118 Module can change as required.



UK Socket+Tel Socket

Model No.:
SH5-008

13A/250V~
 1 pcs/box 20pcs/carton
 33x38x33 cm



UK Socket+Data Socket

Model No.:
SH5-009

13A/250V~
 1 pcs/box 20pcs/carton
 33x38x33 cm



Tel+Data Socket

Model No.:
SH5-010

13A/250V~
 1 pcs/box 20pcs/carton
 33x38x33 cm



Double MF Floor Socket

Model No.:
SH5-011

2x13A/250V~
 1 pcs/box 20pcs/carton
 33x38x33 cm



MF Socket+Tel Socket

Model No.:
SH5-012

13A/250V~
 1 pcs/box 20pcs/carton
 33x38x33 cm



UK Socket+Tel Socket

Model No.:
SH5-013

13A/250V~
 1 pcs/box 20pcs/carton
 33x38x33 cm



UK Socket+Data Socket

Model No.:
SH5-014

13A/250V~
 1 pcs/box 20pcs/carton
 33x38x33 cm



Tel+Data Socket

Model No.:
SH5-015

13A/250V~
 1 pcs/box 20pcs/carton
 33x38x33 cm



Double MF Floor Socket

Model No.:
SH5-001

2x13A/250V~
 1 pcs/box 20pcs/carton
 33x38x33 cm



MF Socket+Tel Socket

Model No.:
SH5-002

13A/250V~
 1 pcs/box 20pcs/carton
 33x38x33 cm



UK Socket+Tel Socket

Model No.:
SH5-003

13A/250V~
 1 pcs/box 20pcs/carton
 33x38x33 cm



UK Socket+Data Socket

Model No.:
SH5-004

13A/250V~
 1 pcs/box 20pcs/carton
 33x38x33 cm



Tel+Data Socket

Model No.:
SH5-005

13A/250V~
 1 pcs/box 20pcs/carton
 33x38x33 cm



Double MF Floor Socket

Model No.:
SH5-006

2x13A/250V~
 1 pcs/box 20pcs/carton
 33x38x33 cm



MF Socket+Tel Socket

Model No.:
SH5-007

13A/250V~
 1 pcs/box 20pcs/carton
 33x38x33 cm



Tel: +852 2581 3588
Fax: +852 2581 3444
Email: ravi@sherav.com.hk
Web: sheravbm.com