

# Piping

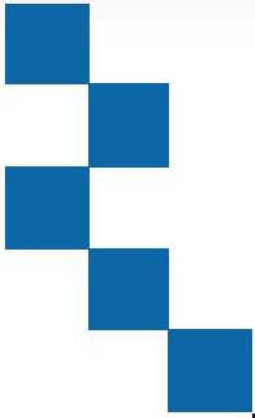

■ PVC Rainwater Gutter & Fitting



## PVC Raineater Gutter & Fitting

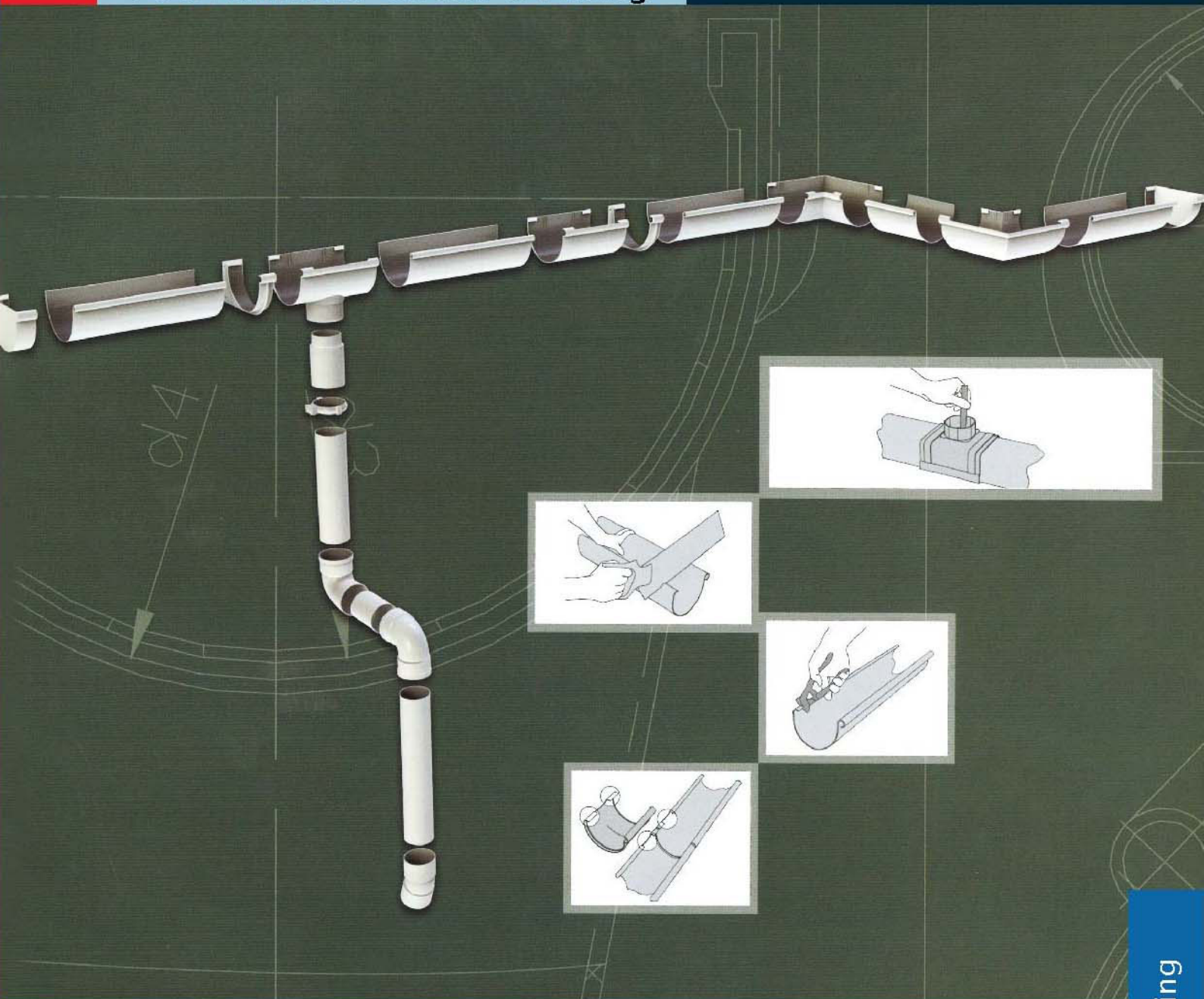

## PVC RAINWATER GUTTER & FITTING

# Piping

## PVC Rainwater Gutter & Fitting

### PVC Gutter System Characteristic

1. Double-wall internal structure designed to keep the lasting strength and stiffness.
2. High temperature resistant PVC material, can withstand long time of sunlight exposure.
3. Easy installation, no need of special tools.
4. The whole gutter system, beautiful shape, elegant colour and lustre.

### Installation Points

- **First Step:** Draw horizontal mounting lines, stainless crews hanging the gutter connector.
- **Second Step:** Install gutters, use the rivet and lap way connect the gutter and gutter(lap joints need special glue)
- **Third Step:** Pre-install downspouts, confirm the location of the drain, install the accessory that connect the gutter and downspout(gutter outlet)
- **Fourth Step:** Install downspouts, confirm the location of the downspout bracket, the space between the downspout brackets, is not more than 1.2m, use the stainless screw to hang the downspout bracket.

### Node Treatment of PVC Gutter System

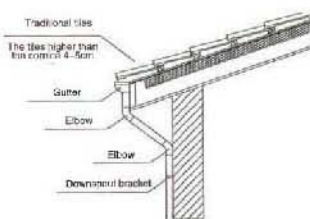

The node of traditional eaves

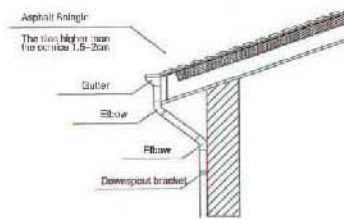

The node of asphalt Shingle

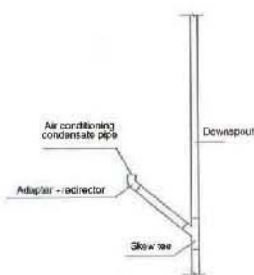

The node of air condition drain

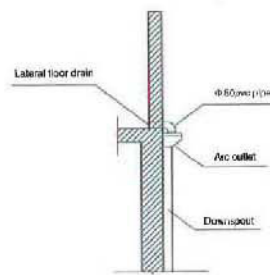

The node of terrace drain

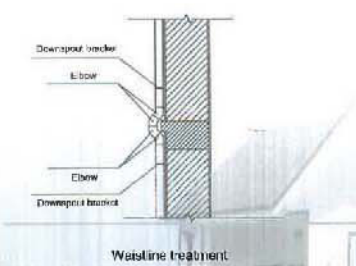

Wallline treatment

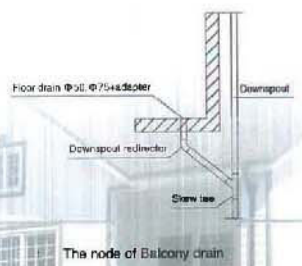

The node of Balcony drain



## PVC Rainwater Gutter & Fitting

### 5 Inch PVC Gutter System

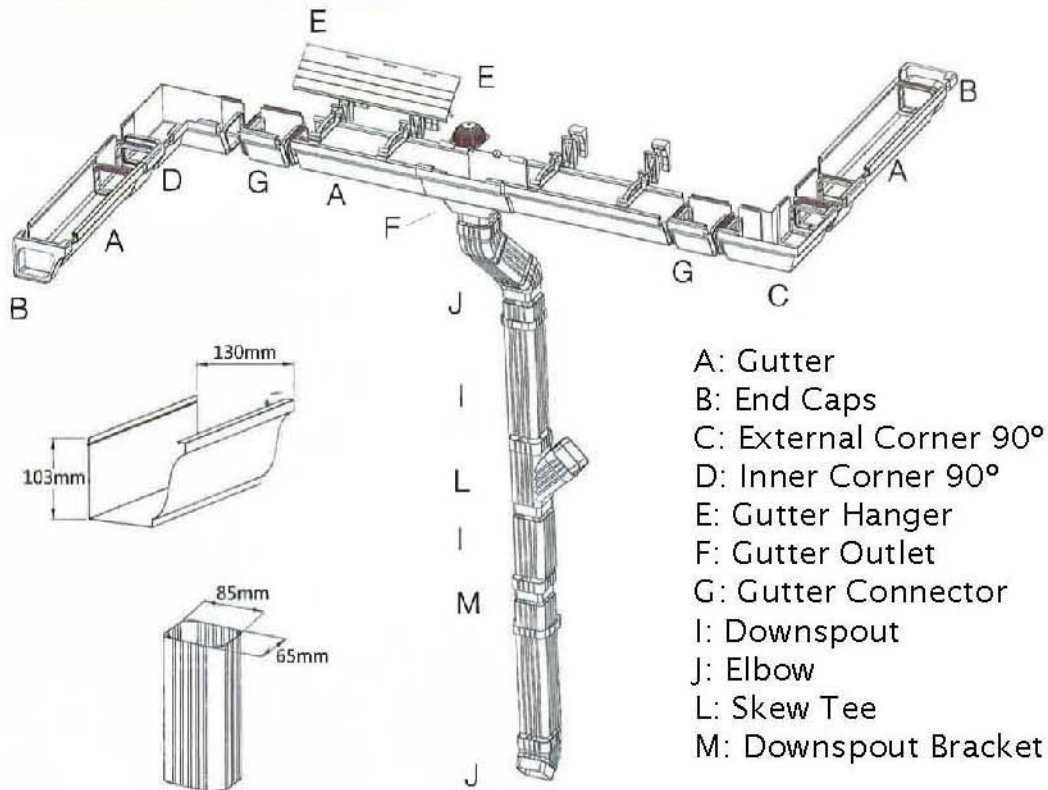

- A: Gutter
- B: End Caps
- C: External Corner 90°
- D: Inner Corner 90°
- E: Gutter Hanger
- F: Gutter Outlet
- G: Gutter Connector
- I: Downspout
- J: Elbow
- L: Skew Tee
- M: Downspout Bracket

### Product



# Piping

## PVC Rainwater Gutter & Fitting



### 110mm Rainwater System Components

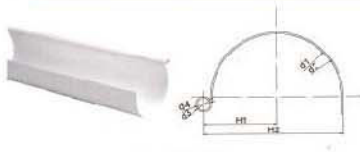

Item No.: RWG-SH001

#### RAIN GUTTER

| Nom Size | d1    | d2    | d3 | d4   | H1   | H2    |
|----------|-------|-------|----|------|------|-------|
| 110      | 118.5 | 121.3 |    | 11.9 | 66.5 | 127.2 |



Item No.: RWG-SH003

#### COUPLING

| Nom Size | d1    | d2    | H     |
|----------|-------|-------|-------|
| 110      | 117.1 | 121.5 | 140.2 |

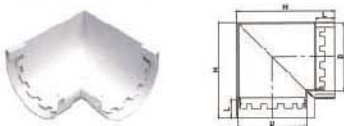

Item No.: RWG-SH004b

#### ANGLE CONNECTOR RIGHT

| Nom Size | H     | L    | D     |
|----------|-------|------|-------|
| 110      | 163.5 | 29.8 | 116.2 |



Item No.: RWG-SH006

#### END CAP LEFT

| Nom Size | d1    | d2    | H     |
|----------|-------|-------|-------|
| 110      | 117.1 | 121.5 | 140.2 |



Item No.: RWG-SH008

#### UDE01 90° ELBOW

| Nom Size | d    | D    | L  |
|----------|------|------|----|
| 110      | 80.5 | 88.5 | 45 |



Item No.: RWG-SH010

#### METAL CLAMP

| Nom Size | d | D | L |
|----------|---|---|---|
| 110      |   |   |   |



Item No.: RWG-SH002

#### TEE

| Nom Size | d1   | d2   | d3    | d4    | H     | L  |
|----------|------|------|-------|-------|-------|----|
| 110      | 75.7 | 79.5 | 115.3 | 119.5 | 201.3 | 47 |



Item No.: RWG-SH004a

#### ANGLE CONNECTOR LEFT

| Nom Size | H   | L    | D     |
|----------|-----|------|-------|
| 110      | 176 | 29.8 | 116.2 |



Item No.: RWG-SH005

#### CLAMP

| Nom Size | D   | H     |
|----------|-----|-------|
| 110      | 121 | 145.6 |



Item No.: RWG-SH007

#### END CAP RIGHT

| Nom Size | d1    | d2    | H     |
|----------|-------|-------|-------|
| 110      | 117.1 | 121.5 | 140.2 |



Item No.: RWG-SH009

#### UDE03 45° ELBOW

| Nom Size | d    | D    | L    |
|----------|------|------|------|
| 110      | 80.5 | 84.5 | 46.7 |



Item No.: RWG-SH011

#### CLIP

| Nom Size | L    | L1 | D  |
|----------|------|----|----|
| 80       | 93.9 | 58 | 80 |



## PVC Rainwater Gutter & Fitting

### 110mm Rainwater System Components

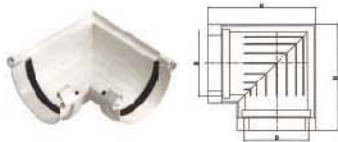

Item No.: RWG-SH004c

#### ANGLE CONNECTOR WITH GASKET

| Nom Size | D      | H      |
|----------|--------|--------|
| 110      | 120.67 | 199.45 |

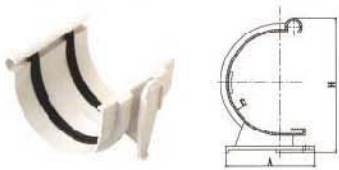

Item No.: RWG-SH003a

#### COUPLING WITH GASKET

| Nom Size | D     | H     | A   |
|----------|-------|-------|-----|
| 110      | 116.2 | 152.3 | 100 |

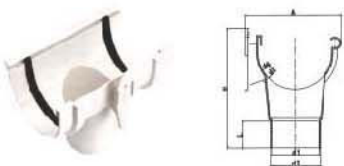

Item No.: RWG-SH002a

#### TEE WITH GASKET

| Nom Size | A     | H     | L  | d1   | d2   | d3    | d4    |
|----------|-------|-------|----|------|------|-------|-------|
| 110      | 152.3 | 191.2 | 43 | 74.4 | 84.5 | 116.2 | 121.2 |

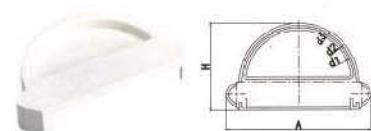

Item No.: RWG-SH005a

#### END CAP TYPE II

| Nom Size | H    | A     | d1  | d2    | d3    |
|----------|------|-------|-----|-------|-------|
| 110      | 88.5 | 146.4 | 112 | 116.2 | 121.2 |



Item No.: RWG-SH010

#### COUPLING M/F

| Nom Size | D    | d  | d1   | L    | H     |
|----------|------|----|------|------|-------|
| 80       | 86.5 | 80 | 74.7 | 85.3 | 137.5 |

### 125mm Rainwater System Components

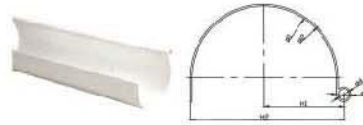

Item No.: RWGS-SH001

#### RAIN GUTTER

| Nom Size | d1  | d2    | d3   | d4   | H1 | H2    |
|----------|-----|-------|------|------|----|-------|
| 125      | 125 | 128.4 | 14.7 | 11.1 | 70 | 134.2 |



Item No.: RWGS-SH003

#### COUPLING

| Nom Size | D   | H   | A   |
|----------|-----|-----|-----|
| 125      | 131 | 210 | 169 |



Item No.: RWGS-SH004

#### ANGLE CONNECTOR

| Nom Size | H   | D   |
|----------|-----|-----|
| 125      | 226 | 131 |

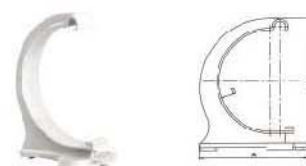

Item No.: RWGS-SH007

#### CLAMP

| Nom Size | D     | H     | A     |
|----------|-------|-------|-------|
| 125      | 131.0 | 171.5 | 142.0 |

# Piping

## PVC Rainwater Gutter & Fitting



### 140mm Rainwater System Components



Item No.: RWGS-SH002

#### TEE

| Nom Size | d1   | d2 | d3  | d4    | H     | L  | A   |
|----------|------|----|-----|-------|-------|----|-----|
| 125      | 74.4 | 80 | 131 | 136.6 | 189.3 | 43 | 169 |

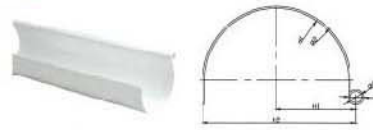

Item No.: RWGM-SH001

#### RAIN GUTTER

| Nom Size | d1  | d2    | d3   | d4   | H1   | H2    |
|----------|-----|-------|------|------|------|-------|
| 140      | 140 | 143.6 | 14.7 | 11.1 | 77.5 | 149.3 |

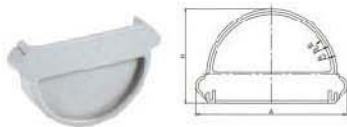

Item No.: RWGS-SH005

#### END CAP

| Nom Size | d1    | d2  | d3    | H    | A     |
|----------|-------|-----|-------|------|-------|
| 125      | 125.8 | 131 | 136.2 | 99.3 | 160.7 |

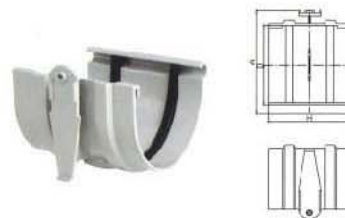

Item No.: RWGM-SH003

#### COUPLING

| Nom Size | D   | H   | A   |
|----------|-----|-----|-----|
| 140      | 145 | 151 | 186 |



Item No.: RWGM-SH004

#### ANGLE CONNECTOR

| Nom Size | H   | D   |
|----------|-----|-----|
| 140      | 245 | 145 |



Item No.: RWGM-SH005

#### END CAP

| Nom Size | d1  | d2  | d3  | H   | A   |
|----------|-----|-----|-----|-----|-----|
| 140      | 139 | 145 | 151 | 110 | 176 |



Item No.: RWGM-SH007

#### CLAMP

| Nom Size | D   | H     | A   |
|----------|-----|-------|-----|
| 140      | 145 | 187.5 | 152 |



Item No.: RWGM-SH002

#### TEE

| Nom Size | d1 | d2 | d3  | d4  | H   | L  | A   |
|----------|----|----|-----|-----|-----|----|-----|
| 140      | 77 | 82 | 145 | 151 | 226 | 45 | 186 |

## PVC Rainwater Gutter & Fitting



### 170mm Rainwater System Components

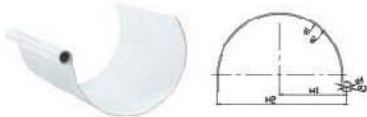

Item No.: RWGL-SH001

#### RAIN GUTTER

| Nom Size | d1  | d2  | d3   | d4   | H1   | H2    |
|----------|-----|-----|------|------|------|-------|
| 170      | 170 | 174 | 16.2 | 12.2 | 93.2 | 180.2 |



Item No.: RWGL-SH002

#### TEE

| Nom Size | d1   | d2  | d3    | d4    | H   | L  |
|----------|------|-----|-------|-------|-----|----|
| 170      | 94.4 | 100 | 176.2 | 181.8 | 159 | 48 |

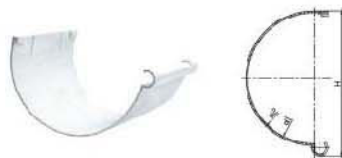

Item No.: RWGL-SH003

#### COUPLING

| Nom Size | d1    | d2    | H   |
|----------|-------|-------|-----|
| 170      | 176.2 | 181.8 | 196 |

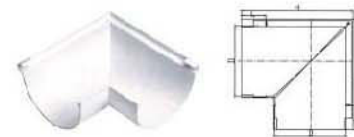

Item No.: RWGL-SH004a

#### ANGLE CONNECTOR LEFT

| Nom Size | H     | L  | D     |
|----------|-------|----|-------|
| 170      | 277.2 | 60 | 176.2 |

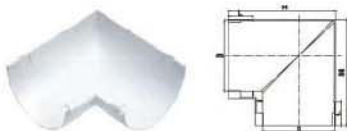

Item No.: RWGL-SH004b

#### ANGLE CONNECTOR RIGHT

| Nom Size | H   | L  | D     |
|----------|-----|----|-------|
| 170      | 263 | 60 | 176.2 |



Item No.: RWGL-SH005

#### END CAP LEFT

| Nom Size | d1    | d2    | H   |
|----------|-------|-------|-----|
| 170      | 176.2 | 181.8 | 196 |



Item No.: RWGL-SH006

#### END CAP RIGHT

| Nom Size | d1    | d2    | H   |
|----------|-------|-------|-----|
| 170      | 176.2 | 181.8 | 196 |

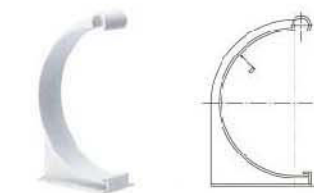

Item No.: RWGL-SH007

#### CLAMP

| Nom Size | D     | H     |
|----------|-------|-------|
| 170      | 176.2 | 206.7 |



### 5.2" Square Rainwater System Components

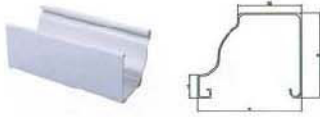

Item No.: RWGA-SH001

#### RAIN GUTTER

| Nom Size | D1  | D2 | H   | h1 |
|----------|-----|----|-----|----|
| 5.2"     | 138 | 90 | 105 | 21 |

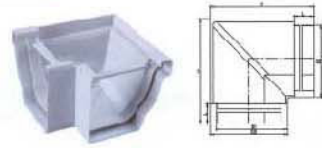

Item No.: RWGA-SH004b

#### 90° OUTSIDE CORNER

| Nom Size | H   | D1 | D2  | L    |
|----------|-----|----|-----|------|
| 5.2"     | 180 | 86 | 135 | 37.5 |

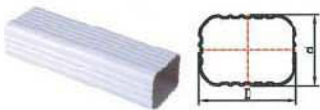

Item No.: RWGA-SH006

#### RECTANGLE PIPE

| Nom Size | D  | d  |
|----------|----|----|
| 5.2"     | 86 | 63 |

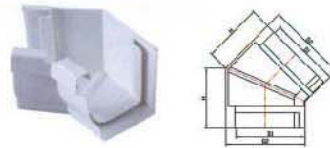

Item No.: RWGA-SH008a

#### 135° INSIDE CORNER

| Nom Size | D1  | D2  | H   |
|----------|-----|-----|-----|
| 5.2"     | 105 | 132 | 105 |



Item No.: RWGA-SH005a

#### LEFT END CAP

| Nom Size | D   | d   |
|----------|-----|-----|
| 5.2"     | 136 | 109 |

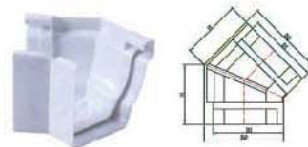

Item No.: RWGA-SH008b

#### 135° OUTSIDE CORNER

| Nom Size | D1  | D2  | H   |
|----------|-----|-----|-----|
| 5.2"     | 105 | 132 | 105 |



Item No.: RWGA-SH005b

#### RIGHT END CAP

| Nom Size | D   | d   |
|----------|-----|-----|
| 5.2"     | 136 | 109 |

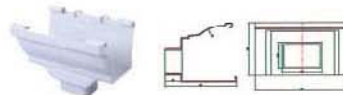

Item No.: RWGA-SH002

#### TEE

| Nom Size | A1  | A2  | H1  | H2 | D   | L1 | L2 |
|----------|-----|-----|-----|----|-----|----|----|
| 5.2"     | 219 | 152 | 173 | 35 | 100 | 79 | 58 |

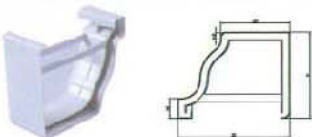

Item No.: RWGA-SH003

#### COUPLING

| Nom Size | D1  | D2 | H   | h1 | h2 |
|----------|-----|----|-----|----|----|
| 5.2"     | 135 | 90 | 108 | 27 | 5  |

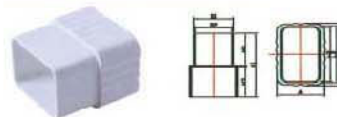

Item No.: RWGA-SH009

#### COUPLING OF PIPE

| Nom Size | A    | L1 | L2 | L3 | D1 | D2 | H1 | H2 | H3 |
|----------|------|----|----|----|----|----|----|----|----|
| 5.2"     | 65.5 | 88 | 80 | 76 | 56 | 52 | 90 | 45 | 43 |

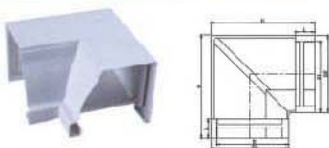

Item No.: RWGA-SH004a

#### 90° INSIDE CORNER

| Nom Size | H   | D1 | D2  | L    |
|----------|-----|----|-----|------|
| 5.2"     | 180 | 86 | 135 | 37.5 |

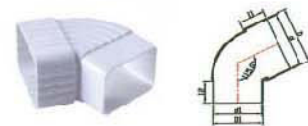

Item No.: RWGA-SH010

#### 65° DIVERTER

| Nom Size | D  | d  | D1 | d1 | l1 | l2 |
|----------|----|----|----|----|----|----|
| 5.2"     | 67 | 63 | 57 | 53 | 41 | 35 |



## PVC Rainwater Gutter & Fitting

### 5.2" Square Rainwater System Components

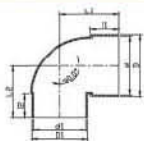

Item No.: RWGA-SH011

#### 90° DIVERTER

| Nom Size | D  | d  | D1 | d1 | L1   | L2   | I1 | I2 |
|----------|----|----|----|----|------|------|----|----|
| 5.2"     | 67 | 63 | 57 | 53 | 73.5 | 64.5 | 41 | 35 |

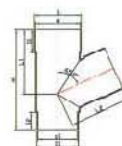

Item No.: RWGA-SH018

#### SKEW TEE

| Nom Size | D  | d  | D1 | d1 | H   | L1    | L2    | I1 | I2 |
|----------|----|----|----|----|-----|-------|-------|----|----|
| 5.2"     | 90 | 86 | 80 | 76 | 198 | 126.6 | 120.2 | 45 | 35 |

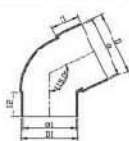

Item No.: RWGA-SH012

#### 65° ELBOW

| Nom Size | D  | d  | D1 | d1 | I1 | I2 |
|----------|----|----|----|----|----|----|
| 5.2"     | 91 | 86 | 80 | 76 | 41 | 35 |

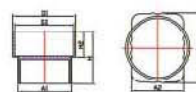

Item No.: RWGA-SH019

#### CONVERSION JOINT

| Nom Size | A1   | A2   | L  | H1 | H2 | D1 | D2 |
|----------|------|------|----|----|----|----|----|
| 5.2"     | 67.5 | 65.5 | 88 | 66 | 33 | 80 | 75 |

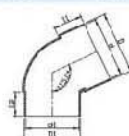

Item No.: RWGA-SH013

#### 90° ELBOW

| Nom Size | D  | d  | D1 | d1 | L1 | L2 | I1 | I2 |
|----------|----|----|----|----|----|----|----|----|
| 5.2"     | 91 | 86 | 80 | 76 | 85 | 57 | 41 | 35 |



Item No.: RWGA-SH014

#### CLIP

| Nom Size | A1  | A2   | H    | D |
|----------|-----|------|------|---|
| 5.2"     | 125 | 88.5 | 61.8 | 5 |



Item No.: RWGA-SH015

#### GUTTER HANGER-SINGLE HOLE

| Nom Size | A  | H   |
|----------|----|-----|
| 5.2"     | 60 | 131 |



Item No.: RWGA-SH007

#### CLAMP

| Nom Size | D1  | D2  | H1 | H2  |
|----------|-----|-----|----|-----|
| 5.2"     | 145 | 101 | 22 | 132 |



# Piping

## PVC Rainwater Gutter & Fitting



### 7" Square Rainwater System Components

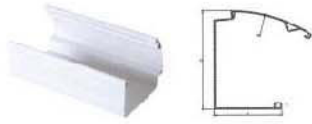

Item No.: RWGB-SH001

#### RAIN GUTTER

| Nom Size | A  | H   | D   |
|----------|----|-----|-----|
| 7"       | 76 | 148 | 100 |



Item No.: RWGB-SH004b

#### 90° OUTSIDE CORNER

| Nom Size | H   | D1    | D2    | L    |
|----------|-----|-------|-------|------|
| 7"       | 220 | 134.2 | 156.5 | 51.5 |

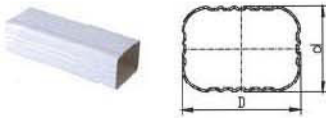

Item No.: RWGB-SH006

#### RECTANGLE PIPE

| Nom Size | D1  | d  |
|----------|-----|----|
| 7"       | 100 | 80 |

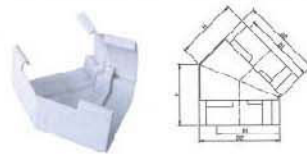

Item No.: RWGB-SH008a

#### 135° INSIDE CORNER

| Nom Size | D1  | D2  | H   |
|----------|-----|-----|-----|
| 7"       | 140 | 160 | 120 |



Item No.: RWGB-SH005a

#### LEFT END CAP

| Nom Size | D1  | d  |
|----------|-----|----|
| 7"       | 100 | 80 |

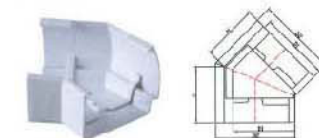

Item No.: RWGB-SH008b

#### 135° OUTSIDE CORNER

| Nom Size | D1  | D2  | H   |
|----------|-----|-----|-----|
| 7"       | 137 | 154 | 120 |



Item No.: RWGB-SH005b

#### RIGHT END CAP

| Nom Size | D1  | d  |
|----------|-----|----|
| 7"       | 100 | 80 |

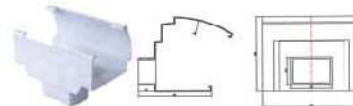

Item No.: RWGB-SH002

#### TEE

| Nom Size | A1  | A2  | H1  | H2 | D   | L1 | L2 |
|----------|-----|-----|-----|----|-----|----|----|
| 7"       | 231 | 156 | 155 | 49 | 150 | 94 | 71 |

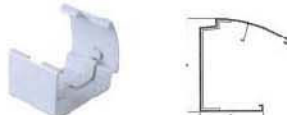

Item No.: RWGB-SH003

#### COUPLING

| Nom Size | A  | H   | D   |
|----------|----|-----|-----|
| 7"       | 83 | 156 | 150 |

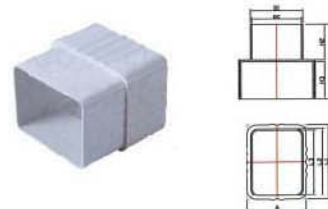

Item No.: RWGB-SH009

#### COUPLING OF PIPE

| Nom Size | A    | L1  | L2   | L3   | D1 | D2 | H1  | H2 | H3   |
|----------|------|-----|------|------|----|----|-----|----|------|
| 7"       | 82.5 | 105 | 94.5 | 90.5 | 72 | 68 | 105 | 50 | 52.5 |

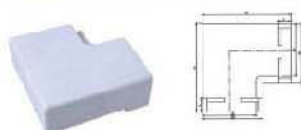

Item No.: RWGB-SH004a

#### 90° INSIDE CORNER

| Nom Size | H   | D1  | D2  | L    |
|----------|-----|-----|-----|------|
| 7"       | 220 | 135 | 157 | 51.5 |



## PVC Rainwater Gutter & Fitting

### 7" Square Rainwater System Components

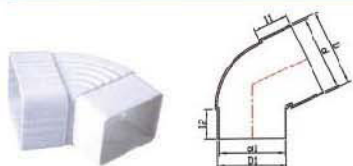

Item No.: RWGB-SH010

#### 65° DIVERTER

| Nom Size | D  | d  | D1 | d1 | I1 | I2 |
|----------|----|----|----|----|----|----|
| 7"       | 83 | 79 | 73 | 69 | 54 | 50 |

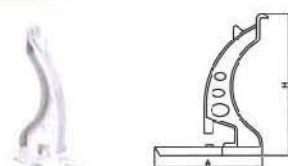

Item No.: RWGB-SH007

#### U HANGER

| Nom Size | A  | H   |
|----------|----|-----|
| 7"       | 87 | 151 |

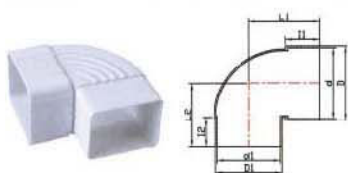

Item No.: RWGB-SH011

#### 90° DIVERTER

| Nom Size | D  | d  | D1 | d1 | L1   | L2   | I1 | I2 |
|----------|----|----|----|----|------|------|----|----|
| 7"       | 83 | 79 | 73 | 69 | 93.5 | 88.5 | 54 | 50 |



Item No.: RWGB-SH019

#### CONVERSION JOINT

| Nom Size | A1  | A2  | L    | H1   | H2   | D1 | D2 |
|----------|-----|-----|------|------|------|----|----|
| 7"       | 105 | 105 | 82.5 | 95.5 | 45.5 | 80 | 75 |

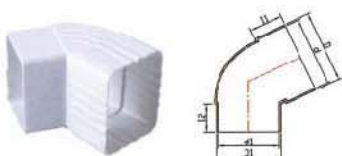

Item No.: RWGB-SH012

#### 65° ELBOW

| Nom Size | D   | d   | D1 | d1 | I1 | I2 |
|----------|-----|-----|----|----|----|----|
| 7"       | 105 | 101 | 94 | 90 | 54 | 50 |

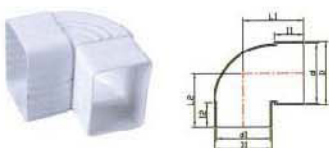

Item No.: RWGB-SH013

#### 90° ELBOW

| Nom Size | D   | d   | D1 | d1 | L1  | L2   | I1 | I2 |
|----------|-----|-----|----|----|-----|------|----|----|
| 7"       | 105 | 101 | 94 | 90 | 106 | 98.5 | 54 | 50 |



Item No.: RWGB-SH014

#### CLIP

| Nom Size | A1    | A2    | H  | D |
|----------|-------|-------|----|---|
| 7"       | 141.6 | 106.8 | 71 | 5 |



# Piping

## PVC Rainwater Gutter & Fitting



### 125mm Square Rainwater System Components

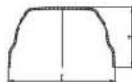

Item No.: RWGF-SH001

#### SQUARE RAIN GUTTER

| Nom Size | D     | H     |
|----------|-------|-------|
| 125      | 129.1 | 73.58 |

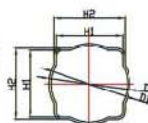

Item No.: RWGF-SH007

#### SQUARE RAIN PIPE

| Nom Size | H1 | H2 | D1 | D2 |
|----------|----|----|----|----|
| 74       | 61 | 65 | 70 | 74 |

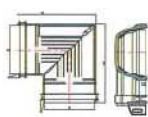

Item No.: RWGF-SH004

#### SQUARE ELBOW

| Nom Size | D     | H      |
|----------|-------|--------|
| 125      | 128.7 | 206.02 |

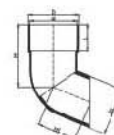

Item No.: RWGF-SH009

#### SQUARE 45 ELBOW

| Nom Size | D  | d    | D1 | H  | L  | H1   |
|----------|----|------|----|----|----|------|
| 74       | 79 | 74.5 | 74 | 98 | 42 | 61.7 |

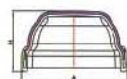

Item No.: RWGF-SH005

#### SQUARE END CAP

| Nom Size | A      | H     |
|----------|--------|-------|
| 125      | 148.11 | 85.27 |

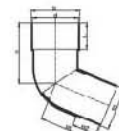

Item No.: RWGF-SH008

#### SQUARE 45 ELBOW M/F

| Nom Size | D  | d    | D1 | H  | L  | H1   | H2   |
|----------|----|------|----|----|----|------|------|
| 74       | 79 | 74.5 | 70 | 98 | 42 | 93.5 | 39.5 |

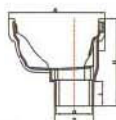

Item No.: RWGF-SH002

#### SQUARE TEE

| Nom Size | A      | D     | d  | H     | L  |
|----------|--------|-------|----|-------|----|
| 125      | 148.51 | 60.17 | 56 | 135.8 | 38 |

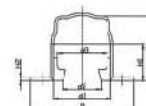

Item No.: RWGF-SH011

#### SQUARE U CLAMP

| Nom Size | D   | d1 | d2 | d3 | H    | H1 | H2  |
|----------|-----|----|----|----|------|----|-----|
| 74       | 134 | 74 | 50 | 65 | 82.7 | 47 | 4.5 |



Item No.: RWGF-SH006

#### SQUARE CLAMP

| Nom Size | A     | H      |
|----------|-------|--------|
| 125      | 105.3 | 130.09 |

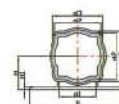

Item No.: RWGF-SH010

#### SQUARE COUPLING M/F

| Nom Size | D     | d1 | d2 | d3 | H    | H1  |
|----------|-------|----|----|----|------|-----|
| 74       | 134.5 | 52 | 65 | 70 | 47.5 | 4.5 |

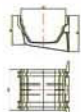

Item No.: RWGF-SH003

#### SQUARE COUPLING

| Nom Size | A     | D     | D1  | H      |
|----------|-------|-------|-----|--------|
| 125      | 104.6 | 85.13 | 121 | 130.09 |

